



USER GUIDE

Cisco Small Business Pro

SPA 500 Series IP Phones

Models 501G, 502G, 504G, 508G, and 509G

CCDE, CCENT, CCSI, Cisco Eos, Cisco HealthPresence, Cisco IronPort, the Cisco logo, Cisco Lumin, Cisco Nexus, Cisco Nurse Connect, Cisco Pulse, Cisco StackPower, Cisco StadiumVision, Cisco TelePresence, Cisco Unified Computing System, Cisco WebEx, DCE, Flip Channels, Flip for Good, Flip Mino, Flipshare (Design), Flip Ultra, Flip Video, Flip Video (Design), Instant Broadband, and Welcome to the Human Network are trademarks; Changing the Way We Work, Live, Play, and Learn, Cisco Capital, Cisco Capital (Design), Cisco:Financed (Stylized), Cisco Store, and Flip Gift Card are service marks; and Access Registrar, Aironet, AllTouch, AsyncOS, Bringing the Meeting To You, Catalyst, CCDA, CCDP, CCIE, CCIP, CCNA, CCNP, CCSP, CCVP, Cisco, the Cisco Certified Internetwork Expert logo, Cisco IOS, Cisco Press, Cisco Systems, Cisco Systems Capital, the Cisco Systems logo, Cisco Unity, Collaboration Without Limitation, Continuum, EtherFast, EtherSwitch, Event Center, Explorer, Fast Step, Follow Me Browsing, FormShare, GainMaker, GigaDrive, HomeLink, iLYNX, Internet Quotient, IOS, iPhone, iQuick Study, IronPort, the IronPort logo, Laser Link, LightStream, Linksys, MediaTone, MeetingPlace, MeetingPlace Chime Sound, MGX, Networkers, Networking Academy, Network Registrar, PCNow, PIX, PowerKEY, PowerPanels, PowerTV, PowerTV (Design), PowerVu, Prisma, ProConnect, ROSA, ScriptShare, SenderBase, SMARTnet, Spectrum Expert, StackWise, The Fastest Way to Increase Your Internet Quotient, TransPath, WebEx, and the WebEx logo are registered trademarks of Cisco Systems, Inc. and/or its affiliates in the United States and certain other countries.

All other trademarks mentioned in this document or website are the property of their respective owners. The use of the word partner does not imply a partnership relationship between Cisco and any other company. (0908R)

Chapter 1: Getting Started	1
About This Document	1
Overview of the Cisco Small Business Pro IP Phones	3
Understanding Your Phone’s Lines and Buttons	4
Phone Components	4
Softkey Buttons	6
Using Keypad Shortcuts	8
Cisco SPA 500S Attendant Console	9
Caring for Your Phone	10
Chapter 2: Installing Your Phone	11
Before You Begin	12
Phone Connections	12
Connecting the Handset	13
Installing the Stand (Optional)	13
Mounting the Phone to the Wall (Optional)	14
Reversing the Handset Retention Tab	18
Connecting the Power	19
Connecting Your Phone to the Network	20
Connecting the Phone to the Wireless Network	20
Connecting a PC to Your Phone (Optional)	21
Connecting Wired and Wireless Headsets (Optional)	21
Verifying Phone Startup	22
Upgrading Your Phone’s Firmware	23
Determining Your Current Firmware Version	23
Download the Firmware	24
Get Your Phone’s IP Address	24
Install the Firmware	25

Chapter 3: Using Basic Phone Functions	26
Using Phone Hardware and Accessories	27
Using the Speakerphone	27
Using the Headset with Your IP Phone	27
Switching Between the Handset/Headset/Speakerphone During a Call	27
Sending Audio to the Phone Speaker	27
Choosing Your Preferred Audio Device	28
Adjusting Call Volume and Muting	29
Adjusting Call Volume	29
Adjusting the Ringer Volume	29
Using Mute	29
Placing or Answering a Call	29
Using Dial Assistance	30
Putting a Call on Hold	30
Resuming a Call	31
Ending a Call	31
Transferring Calls	31
Performing an Attended Transfer	32
Performing an Unattended (Blind) Transfer	32
Transferring a Held Call to an Active Call	33
Redialing	33
Viewing and Returning Missed Calls	34
Turning the Missed Calls Shortcut On and Off	35
Forwarding Calls	35
Forwarding All Calls	36
Forwarding Calls When Your Phone is Busy	36
Forwarding Calls When You Don't Answer the Phone	37
Delaying Call Forwarding When You Don't Answer the Phone	37
Stopping Call Forwarding	38

Setting Do Not Disturb	38
Activating Do Not Disturb	38
Deactivating Do Not Disturb	39
Turning Call Waiting On and Off	39
Picking Up a Call	40
Parking a Call	41
Placing a Three-Way Conference Call	42
Conferencing a Held Call with an Active Call	43
Using the Phone Directories	44
Using Your Personal Directory	44
Using the Corporate Directory	45
Using the Call History Lists	46
Viewing the Call History Lists	46
Calling from the Call History Lists	47
Deleting a Number from the Call History Lists	47
Saving a Call History List Number to Your Directory	47
Setting or Changing a Phone Password	48
Accessing Voicemail	48

Chapter 4: Using Advanced Phone Features **49**

Configuring Privacy and Security Features	50
Blocking Caller ID	50
Blocking Anonymous Calls	50
Using Secure Call	51
Enabling Dial Assistance	52
Creating Speed Dials	52
Creating Speed Dials on Unused Line Buttons	53
Creating Numerical Speed Dials	53
Using Speed Dials	54
Using the Paging Feature	54
Paging Another Phone	55

Paging a Group of Phones	55
Configuring Auto Answer	55
Monitoring/Accessing Another Phone from Your Phone	55
Customizing Your LCD Screen	56
Changing the LCD Screen Contrast	56
Changing the Screen Backlight Settings	57
Configuring the Phone Screen Saver	57
Turning on the Screen Saver	59
Using Ring Tones	59
Changing Your Ring Tone	59
Configuring Date and Time Parameters on Your Phone	60
Setting Your Phone's Date and Time	60
Using Star Codes	60
Using the Interactive Voice Response Menu on the Cisco SPA 501G	62
Advanced Procedures for Technical Support Personnel	65
Rebooting Your Phone	66

Chapter 5: Using the Web Interface 67

Logging in to the Web Interface	68
Setting Do Not Disturb	69
Configuring Call Forwarding	69
Configuring Call Waiting	70
Blocking Caller ID	71
Blocking Anonymous Calls	71
Using Your Personal Directory	72
Viewing Call History Lists	72
Creating Speed Dials	73
Accepting Text Messages	73
Adjusting Audio Volume	74
Changing the LCD Contrast	75

Configuring the Phone Screen Saver	75
------------------------------------	----

Chapter 6: Using the Cisco SPA 500S Attendant Console **77**

Connecting the Cisco SPA 500S Attendant Console to the IP Phone	78
---	----

Connecting a Single Cisco SPA 500S	79
------------------------------------	----

Connecting a Second Cisco SPA 500S	83
------------------------------------	----

Configuring the Cisco SPA 500S	85
--------------------------------	----

Using the Cisco SPA 500S	86
--------------------------	----

Monitoring the Cisco SPA 500S	86
-------------------------------	----

Appendix A: Where to Go From Here **87**

Getting Started

This chapter provides an overview of this document and basic information about your Cisco Small Business Pro IP phone. It contains the following sections:

- [About This Document, page 1](#)
- [Overview of the Cisco Small Business Pro IP Phones, page 3](#)
- [Understanding Your Phone's Lines and Buttons, page 4](#)

About This Document

This guide describes the concepts and tasks necessary to use and configure your Cisco Small Business Pro IP Phone.



NOTE

The Cisco Small Business Pro IP Phone features vary, depending on the type of call control system that you are using. **This document describes using the Cisco Small Business Pro IP Phones with a SIP phone system, such as the Cisco SPA 9000 Voice System or a Broadsoft or Asterisk system.** If you are using your Cisco Small Business Pro IP Phone with a Cisco Unified Communications 500 Series, see the *Cisco Unified Communications Manager Express for Cisco Small Business Pro IP Phone SPA 50X (SPCP) User Guide*.

Organization

This table describes the contents of each chapter in this document.

	Title	Description
Chapter 1	Getting Started	A description of this book and an overview of the Cisco Small Business Pro IP Phones.
Chapter 2	Installing Your Phone	How to connect and install your phone.
Chapter 3	Using Basic Phone Functions	How to perform basic phone tasks, such as placing and answering calls, transferring calls, setting up call forwarding, and picking up calls.
Chapter 4	Using Advanced Phone Features	How to perform advanced phone tasks, such as configuring privacy and security features, speed dials, paging, and ring tones.
Chapter 5	Using the Web Interface	How to log in to and use the phone's web user interface.
Chapter 6	Using the Cisco SPA 500S Attendant Console	How to use the Cisco SPA 500S.
Appendix A	Where to Go From Here	Lists of and links to related documentation.

Overview of the Cisco Small Business Pro IP Phones

The Cisco Small Business Pro IP Phones are full-featured VoIP (Voice over Internet Protocol) phones that provide voice communication over an IP network. The phones provide traditional features, such as call forwarding, redialing, speed dialing, transferring calls, conference calling and accessing voice mail. Calls can be made or received with a handset, headset or over a speaker.

IP phones also have special features not available in traditional phones. The Cisco Small Business Pro IP phones contain Ethernet ports, or ports that allow them to be linked to the computer network. They also have additional Ethernet ports that allow a computer to be connected to the network through the IP phone.

Unlike traditional phones, Cisco Small Business Pro IP phones require a separate power source. You can power the phones by connecting them to a switch that provides Power over Ethernet (PoE), or by using an optional PA100 power adapter.

The following table shows the Cisco Small Business Pro IP Phones covered in this document and their respective features:

	SPA 501G	SPA 502G	SPA 504G	SPA 508G	SPA 509G
Screen	Paper labels	128 X 64 monochrome LCD with backlight			
Lines	8	1	4	8	12
Softkeys	4 fixed (redial, cancel, conference, and transfer)	4 dynamic			
Navigation Button	None	Four-way navigation key			

Understanding Your Phone's Lines and Buttons

Use the following graphic and table to identify the parts of your phone.

Phone Components







Figure 1 Phone Components

The photo above shows the Cisco SPA 509G to illustrate the Cisco Small Business Pro IP Phone features. Other models differ. See the **“Overview of the Cisco Small Business Pro IP Phones”** section on page 3.

Numbered objects in the photo are explained in the following table.

#	Phone Feature	Description
1	Handset	Pick up to place or answer a call.
2	Message Waiting Indicator	Displays solid red when you have a new voice mail message. Flashes red during an incoming call.

#	Phone Feature	Description
3	LCD Screen	Displays date and time, phone station name, line extensions, and softkey options. (Not available on the Cisco SPA 501G.)
4	Line keys	<p>Indicates phone line status. (Not available on the Cisco SPA 502G.)</p> <p>When lit:</p> <p>Green: Line is idle.</p> <p>Red (steady): Line is active or in use.</p> <p>Red (blinking): Line is on hold.</p> <p>Orange: Line is unregistered (cannot be used).</p> <p>These keys can also be programmed by your phone system administrator to perform functions such as speed dial, call pickup, or monitoring an extension.</p>
5	Softkey buttons	<p>Press a softkey button to perform the action shown on the label on the LCD screen above.</p> <p>Note: The Cisco SPA 501G has the following four buttons:</p> <p> Redial—Dials the last number called.</p> <p> Cancel—Cancels an action (such as a transfer).</p> <p> Conference—While on a call, press to start a conference call and dial another number. After the second party answers, press Conference again to create the conference.</p> <p> Transfer—Transfers a call. See the “Transferring Calls” section on page 31.</p>
6	Navigation button	Press an arrow key to scroll left, right, up, or down through items shown on the LCD screen. (Not available on the Cisco SPA 501G.)
7	Messages button	Press to access voice mail (must be set up by your phone system administrator).
8	Hold button	Press to place a call on hold.

#	Phone Feature	Description
9	Setup button	Press to access a menu to configure features and preferences (such as your directory and speed dials), access your call history, and set up functions (such as call forwarding). For the Cisco SPA 501G, accesses the Interactive Voice Response menu, which allows you to perform tasks like getting the IP address of the phone. See the User Guide documents on Cisco.com for more information. (See the list of links at the end of this document.)
10	Mute button	Press to mute or unmute the phone. When phone is muted, the button glows red. A flashing mute button indicates the network connection cannot be found.
11	Volume button	Press + to increase the volume and - to lower the volume of the handset, headset, speaker (when the handset is off the phone, or ringer volume (when the handset is on the phone).
12	Headset button	Push to turn the headset on or off. When the headset is on, the button glows green.
13	Speaker button	Push to turn the speaker on or off. When the speaker is on, the button glows green.
14	Keypad	Use to dial phone numbers, enter letters, and choose menu items.

Softkey Buttons

The softkey buttons on your phone display may vary depending on your phone model and the phone system setup. (Softkey buttons are not available on the Cisco SPA 501G.) Press the **Right Arrow** or **Left Arrow** keys on the navigation button to view additional softkey buttons.

Below is a partial listing of softkey buttons that may be available on your phone. You may not have all of these softkey buttons on your phone, and you may have additional buttons that are not listed here. For example, your phone administrator may also provide custom softkey buttons on your phone, such as buttons that provide a speed dial to a company number, or that access a specialized program that runs on your phone. Contact your phone administrator for more information.

Button	Function
<< or >>	Move left or right through an entry without deleting characters.
activ	Activates screen saver mode.
add	Add an entry.
bXfer	Performs a blind call transfer (transferring a call without speaking to the party to whom you are transferring the call.)
cancel	Cancel any changes you have made (press before ok or save).
cfwd	Forwards all calls coming to your phone to a specified number.
-cfwd	Clears call forwarding.
conf	Initiates a conference call.
confLx	Conferences active lines on the phone together.
delChr	Deletes the last number or letter.
delete	Deletes an entire item (for example, a number from the Call History list).
dial	Dials a number.
dir	Provides access to phone directories.
dnd	Do Not Disturb; prevents incoming calls from ringing your phone.
-dnd	Clears Do Not Disturb.
edit	Opens an item so that you can edit numbers or letters, or enable or disable a feature.
grPick	Allows you to answer a call ringing on an extension by discovering the number of the ringing extension.
ignore	Ignores an incoming call.
lcr	Dials the Last Call Received.
miss	Shows the Missed Calls list.
park	Puts a call on hold at a designated "park" number. The call is parked on the line until you unpark it or the caller disconnects. Must be configured by your phone system administrator.

Button	Function
pickup	Allows you to answer a call ringing on another extension by entering the extension number.
phold	Puts a call on hold on an active shared line.
redial	Displays a list of recently dialed numbers.
resume	Resumes a call that is on hold.
save	Saves your changes.
select	Selects the highlighted item on the LCD screen.
starcode	Allows you to enter a star code. See “Using Star Codes,” on page 60.
unpark	Resumes a parked call.
xfer	Performs a call transfer.
xferLx	Transfers an active line on the phone to a called number.
y/n	Enters a submenu and when pressed, toggles between Yes or No to enable or disable an option.

Using Keypad Shortcuts

When using the phone menus, you can use the keypad to enter the number shown next to the menu or sub-menu item on the LCD screen. (Not applicable to the Cisco SPA 501G.)

For example, to obtain your IP address on the Cisco SPA 504G, press the **Setup** button and dial **9**.

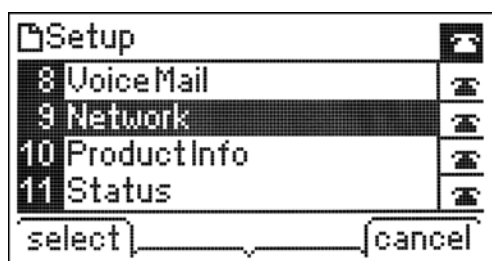

The IP address is displayed on the Network screen.

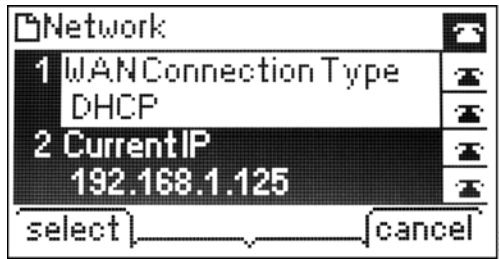

NOTE Menus and options vary depending on phone model.

Cisco SPA 500S Attendant Console

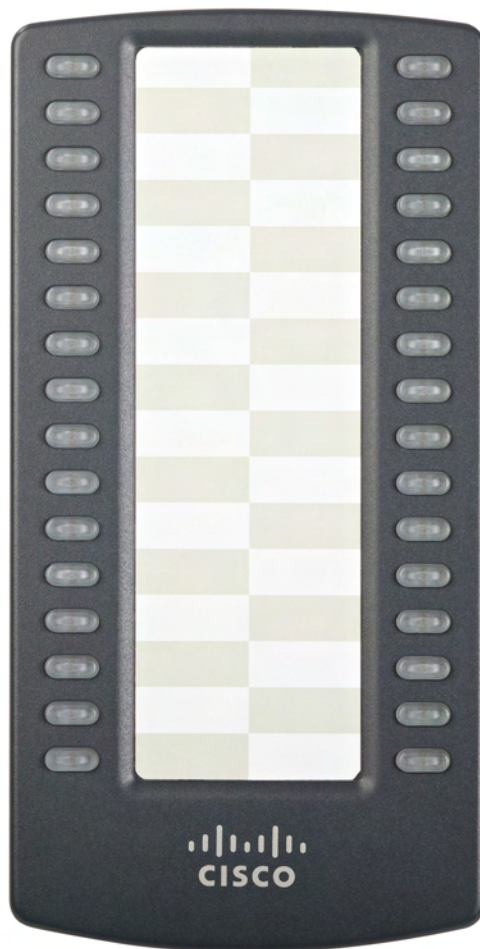

The Cisco SPA 500S is a 32-button attendant console for the Cisco Small Business Pro IP phones, providing 32 three-color (red, green, and amber) programmable LEDs, with support for Broadsoft Busy Lamp Field and Asterisk Line Monitoring. The Cisco SPA 500S attaches to the IP phone with the attachment arm provided (not shown). It obtains power directly from the IP phone and does not require a separate power supply. Two Cisco SPA 500S units can be attached to a single IP phone to monitor a total of 64 separate lines. For more information on the Cisco SPA 500S, see [Chapter 6, “Using the Cisco SPA 500S Attendant Console.”](#)

Caring for Your Phone

The Cisco Small Business Pro IP phones are electronic devices that should not be exposed to excessive heat, sun, cold or water. To clean the equipment, use a slightly moistened paper or cloth towel. Do not spray or pour cleaning solution directly onto the hardware unit.

Installing Your Phone

This chapter describes how to install your Cisco Small Business Pro IP Phone and connect it to your network. It contains the following sections:

- **Before You Begin, page 12**
- **Phone Connections, page 12**
- **Connecting the Handset, page 13**
- **Installing the Stand (Optional), page 13**
- **Mounting the Phone to the Wall (Optional), page 14**
- **Connecting the Power, page 19**
- **Connecting Your Phone to the Network, page 20**
- **Connecting a PC to Your Phone (Optional), page 21**
- **Connecting Wired and Wireless Headsets (Optional), page 21**
- **Verifying Phone Startup, page 22**
- **Upgrading Your Phone's Firmware, page 23**

Before You Begin

Before you install and connect your phone, verify with your System Administrator (if applicable) that the network is ready for the phone, read the safety notices, and make sure you have all the phone parts and documentation available.



NOTE

The RJ-11 port marked “AUX” is reserved for connection with the Cisco SPA 500S Attendant Console that works with the IP phones. It is not for use as a telephone line port.



CAUTION

CAUTION: Do not plug a telephone line cord into the port marked “AUX.”

Phone Connections

The following photo shows where you need to connect parts of the phone.

Figure 1 Phone Connections

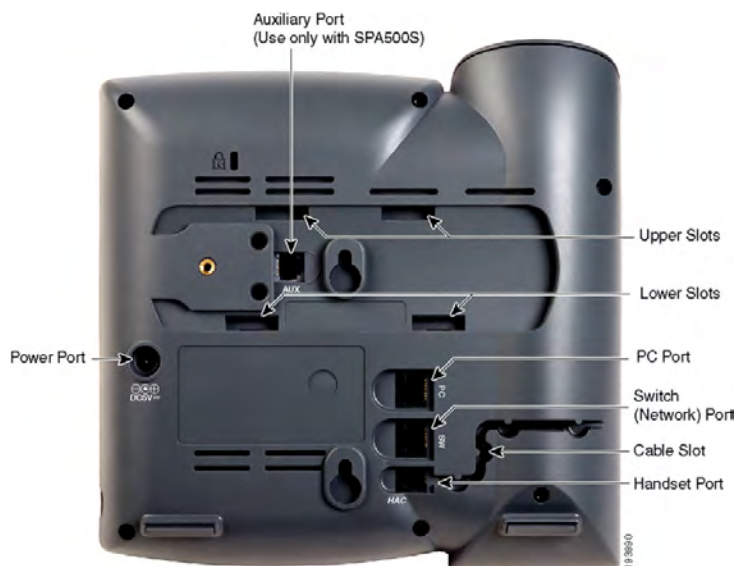

Connecting the Handset

STEP 1 Turn the phone body over to expose the ports on the back of the unit.



CAUTION Do not insert a telephone line cord into the auxiliary port.

STEP 2 Insert the long end of the phone cord into the handset port on the phone body that is marked with a phone symbol.

STEP 3 (Optional) Route the phone cord through the cable slot.

STEP 4 Insert the other end of the phone cord into the port at the bottom of the handset (not shown).

Installing the Stand (Optional)



NOTE Do not attach the desk stand if you want to mount the phone to the wall. If you are attaching a Cisco SPA 500S attendant console, attach the console before attaching the desk stand.

STEP 1 Connect the phone stand by lining up the tabs on the stand with the slots on the phone body.

STEP 2 Slide the bottom tabs into the lower slots on the phone body and lightly press down on the stand. It should easily slide into the upper stand slots. Do not force.

Mounting the Phone to the Wall (Optional)

To mount the phone to the wall, you must purchase the MB100 wall mount bracket kit.

Figure 2 MB100 Wall Mount Kit



- STEP 1** To attach the Mounting Bracket (MB), align the two cleats on the MB with the holes in the phone's base.

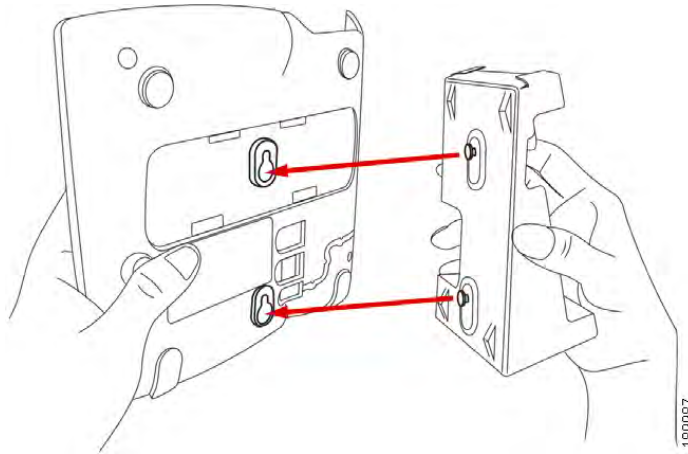

- STEP 2** Orient the MB such that the phone's Ethernet and handset ports are accessible after installation.

- STEP 3** Push the MB onto the phone's base. Slide the MB upwards to lock it in place.

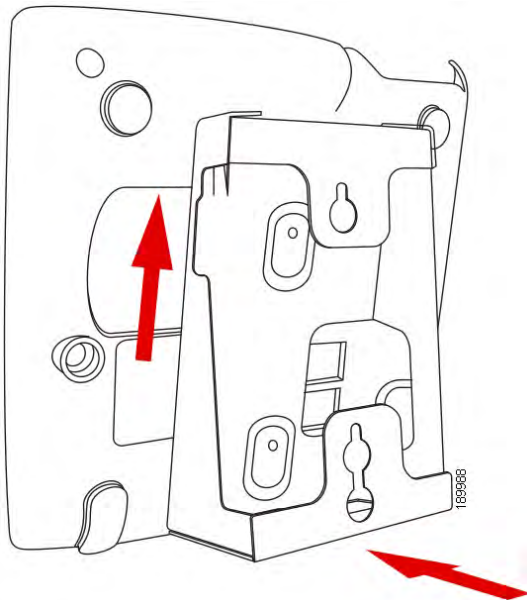

Installing Your Phone

Mounting the Phone to the Wall (Optional)

2

STEP 4 (Optional) If a Wi-Fi or PoE dongle is installed, place in the tray.

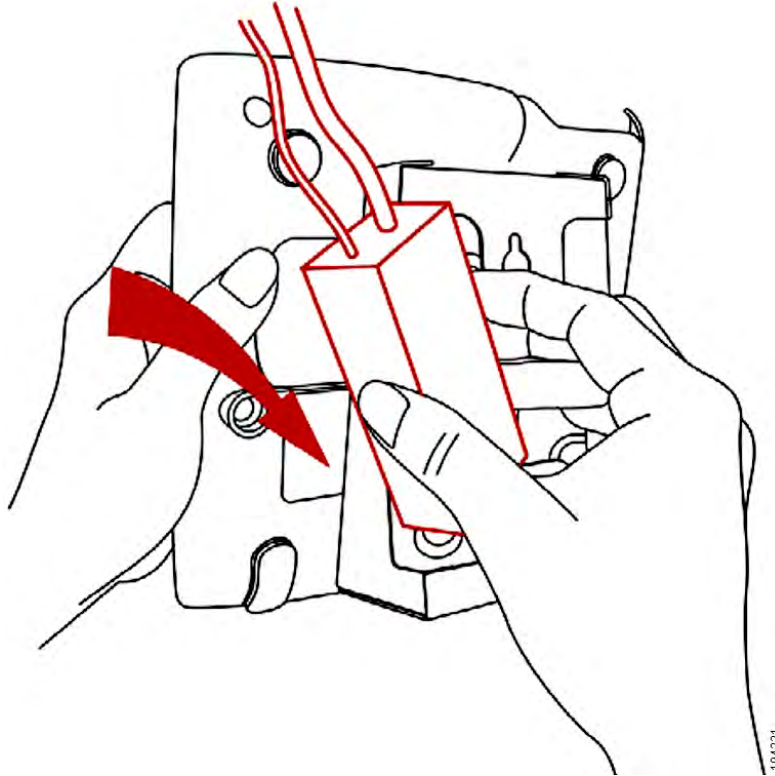

Installing Your Phone

Mounting the Phone to the Wall (Optional)

2

Plug in the Ethernet and power cables.

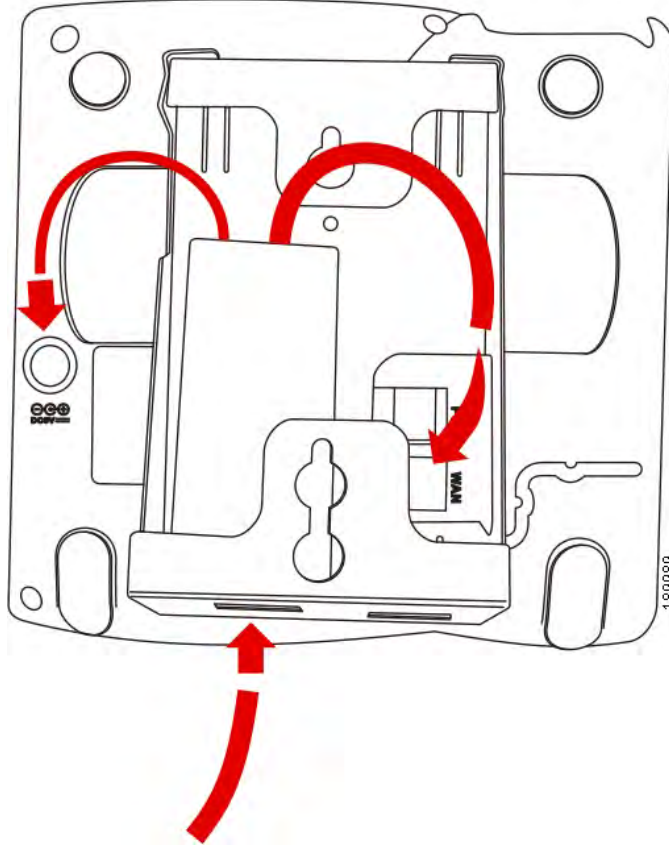

STEP 5 Hang onto screws mounted in the wall.

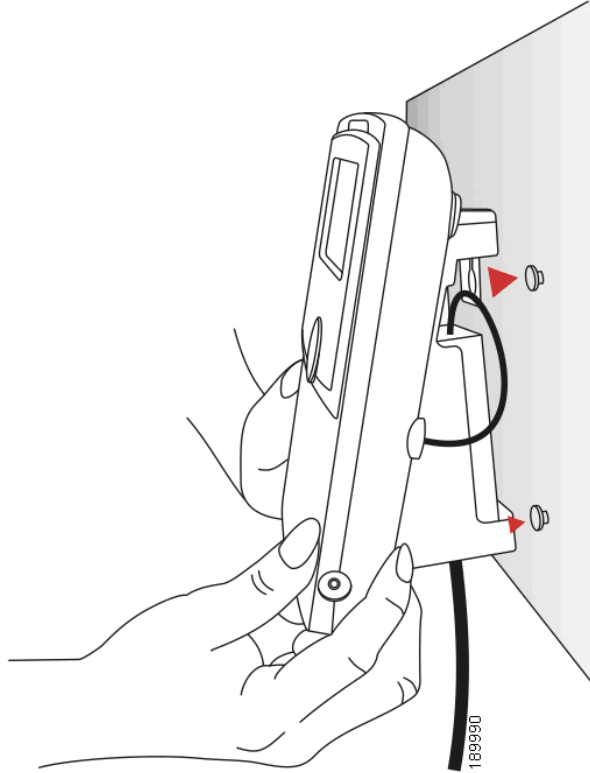

Reversing the Handset Retention Tab

If you mount the phone to a vertical surface, you must reverse the handset retention tab on the phone body so that the handset does not fall off the phone when it is placed on the cradle.

STEP 1 Push the latch in.

STEP 2 Slide the retention tab up until it detaches from the phone.



- STEP 3** Rotate the tab 180° and re-insert into the phone base. The tab now catches the slot in the handset when the handset is placed onto the cradle.

Connecting the Power

If you are using an external power source, insert one end of the power cord into an outlet and insert the other end of the power cord into the power port on the phone body.

Connecting Your Phone to the Network

If you are using an Ethernet connection:

-
- STEP 1** Insert one end of the Ethernet cable into the network port on the phone body marked “SW.”
 - STEP 2** Insert the other end of the Ethernet cable into the appropriate device, such as a network switch, on your network.
-

Connecting the Phone to the Wireless Network

You can use the Cisco WBP54G Wireless-G Bridge for Phone Adapters to connect the IP phone to a Wireless-G network instead of the wired local network.



NOTE

This procedure requires the optional Cisco SPA 9000 Voice System IP Phone PA100 power adapter to provide power to the WBP54G.

To connect your phone to the Cisco WBP54G:

-
- STEP 1** Configure the Cisco WBP54G using the Setup Wizard. See the instructions in the *Wireless-G Bridge for Phone Adapters Quick Installation Guide*, available on cisco.com. See **Appendix A, “Where to Go From Here,”** for a list of documents and locations.
 - STEP 2** During the Setup Wizard process, connect the Ethernet network cable of the WBP54G to the back of the IP phone base station into the slot marked “SW.” See the **“Phone Connections”** graphic.
 - STEP 3** Connect the power cable of the WBP54G to the power port on the IP phone base.
 - STEP 4** Plug the IP phone power adapter into the power port of the WBP54G.
 - STEP 5** Plug the other end of the IP phone power adapter into an electrical outlet.
-

Connecting a PC to Your Phone (Optional)

To connect a PC to your phone (optional):

-
- STEP 1** To provide network access to a PC, connect one end of an additional Ethernet cable (not provided) to the PC port on the back of the phone body. See the “**Phone Connections**” graphic.
- STEP 2** Connect the other end of the Ethernet cable to the network port on your PC.
-

Connecting Wired and Wireless Headsets (Optional)

The IP phones support headsets from different manufacturers. For the latest supported models, contact your reseller. Additional information can be found at the manufacturer’s websites:

<http://www.plantronics.com>

<http://www.jabra.com>

Each brand and type of headset may require different steps for connection. Consult the documentation for your particular headset for more information. In general, to connect a headset:

- **Wireless**—Connect the headset’s telephone cord into the telephone port on the back of the IP Phone.
- **Wired headsets**—Connect the 2.5mm connector from the headset into the headset port on the right side of the IP phone as shown in the following graphic:



Verifying Phone Startup

After receiving power and network connectivity, the phone executes a boot-up sequence. During this sequence, phones with screens display the Cisco logo and then “Initializing Network”. All of the lights on the phone will flash.

After your phone is successfully connected to the network and receives a basic configuration, your phone line keys should glow green (on models with phone line keys).

On models with screens, the phone displays the standard menu for the phone. The date, name and number of the phone display on the top line of the LCD screen. At the bottom of the LCD screen, softkeys are displayed over their associated soft buttons.

On models with no screen, such as the Cisco SPA 501G, the lines should glow green and you should hear a dial tone when picking up the handset or pressing the speakerphone button.

If the phone does not start, confirm your installation and connections. If these are correct, try unplugging the phone and plugging it back in again. If you still don't see the display, then contact your phone administrator or Internet Telephony Service Provider (ITSP).

Upgrading Your Phone's Firmware

Your phone ships with pre-installed firmware. However, later firmware versions may be available that add features and fix problems with your phone. You may need to upgrade your phone to the latest firmware for ideal performance.



CAUTION If you are using your phone with an Internet Telephony Service Provider's system, do not upgrade your phone's firmware without consulting your service provider. Your provider may automatically upgrade your phones without any action on your part necessary.

To upgrade your phone's firmware, do one of the following:

- Download the firmware from the Cisco website and install it from your PC. See the following section for instructions.
- Upgrade using the Cisco SPA 9000 Voice System Setup Wizard (if your phone is part of a Cisco SPA 9000 Voice System network). See the *Cisco SPA 9000 Voice System Setup Wizard User Guide*.

Determining Your Current Firmware Version

Cisco SPA 502G, SPA 504G, SPA 508G, SPA 509G:

STEP 1 Press the **Setup** button.

STEP 2 Scroll to **Product Info** and press **select**.

STEP 3 Scroll to **Software Version**. The firmware version number is displayed.

Cisco SPA 501G:

- STEP 1** Press the **Setup** button.
 - STEP 2** Enter **150**, then press **#**. The firmware version is recited.
-

Download the Firmware

Go to www.tools.cisco.com/support/downloads, and enter the model number in the Software Search box. Save the firmware to your desktop.

Get Your Phone's IP Address

Before you upgrade, you'll need the IP address of the phone you are upgrading. To get your IP address:

Cisco SPA 502G, SPA 504G, SPA 508G, SPA 509G:

-
- STEP 1** Press the **Setup** button.
 - STEP 2** Scroll to **Network** and press **select**.
 - STEP 3** Scroll to view **Current IP**. This is the IP address of your phone.
-

SPA 501G:

-
- STEP 1** Press the **Setup** button.
 - STEP 2** Enter **110**, then press **#**. The IP address is recited.
-

Install the Firmware

STEP 1 Extract the firmware onto your PC.



NOTE

If you are in a VPN connection, you may need to disconnect before proceeding so that your PC can communicate directly with your phone for the upgrade.

STEP 2 Run the executable file for the firmware upgrade (for example, double click **upg-spa504-6-2-0.exe**).

STEP 3 Click **Continue** after reading the message regarding upgrading and your service provider.

STEP 4 Enter the IP address of your phone and verify the address of your PC.

STEP 5 Click **OK**. The system displays information about your phone's current software and hardware.

STEP 6 Click **Upgrade** to begin the upgrade.



NOTE

Do not disconnect your phone's power until the upgrade is complete (the lights on your phone are no longer blinking).

STEP 7 Click **OK** to dismiss the status message of the upgrade.

Using Basic Phone Functions

This chapter provides instructions on using your phone's basic functions. It includes the following sections:

- [Using Phone Hardware and Accessories, page 27](#)
- [Adjusting Call Volume and Muting, page 29](#)
- [Placing or Answering a Call, page 29](#)
- [Putting a Call on Hold, page 30](#)
- [Resuming a Call, page 31](#)
- [Ending a Call, page 31](#)
- [Transferring Calls, page 31](#)
- [Redialing, page 33](#)
- [Viewing and Returning Missed Calls, page 34](#)
- [Turning the Missed Calls Shortcut On and Off, page 35](#)
- [Forwarding Calls, page 35](#)
- [Setting Do Not Disturb, page 38](#)
- [Turning Call Waiting On and Off, page 39](#)
- [Picking Up a Call, page 40](#)
- [Parking a Call, page 41](#)
- [Placing a Three-Way Conference Call, page 42](#)
- [Using the Phone Directories, page 44](#)
- [Using the Call History Lists, page 46](#)
- [Setting or Changing a Phone Password, page 48](#)
- [Accessing Voicemail, page 48](#)

Using Phone Hardware and Accessories

Using the Speakerphone

To use the speakerphone, press the **Speaker** button (the handset can be either on or off hook).

Using the Headset with Your IP Phone

Install the headset as described in the “**Connecting Wired and Wireless Headsets (Optional)**” section on page 21.



NOTE

Steps to use your headset with the IP phone may vary. Consult the user documentation for your headset for more information.

To use a wired headset, press the **Headset** button on your phone and dial the number to place a call, or press the headset button to answer a ringing call.

To use a wireless headset, lift the receiver off hook before speaking or listening through the headset.

Switching Between the Handset/Headset/Speakerphone During a Call

Any of these audio devices can be used during a call. Only one device at a time can be used.

The handset can be on the hook when using the speakerphone or headset function. If switching from the handset to the speakerphone, make sure the speakerphone or headset light is illuminated before placing the handset back on the hook. (If you are switching from the handset to a wireless headset, however, do not replace the handset or you will disconnect the call.)

Sending Audio to the Phone Speaker

Choosing this option sends audio to the speaker when the handset is lifted.



NOTE Does not apply to the Cisco SPA 501G.

- STEP 1** Press the **Setup** button.
 - STEP 2** Select **Preferences**.
 - STEP 3** Choose **Send Audio to Speaker > edit**.
 - STEP 4** Press **y/n** to enable or disable the feature.
 - STEP 5** Press **ok**.
 - STEP 6** Press **save**.
-

Choosing Your Preferred Audio Device

This option designates the headset or speaker phone as the preferred audio device when the handset is not used.



NOTE Does not apply to the Cisco SPA 501G.

To choose your preferred audio device:

- STEP 1** Press the **Setup** button.
 - STEP 2** Select **Preferences**.
 - STEP 3** Choose **Preferred Audio Device** and press **edit**.
 - STEP 4** Press **option** to view your choices. When the option you want is displayed, press **ok**.
 - STEP 5** Press **save**.
-

Adjusting Call Volume and Muting

You can also change call volume settings from your PC using the IP Phone Web Interface. See [“Adjusting Audio Volume” section on page 74](#).

Adjusting Call Volume

To adjust the volume of the handset or speaker, lift the handset or press the **Speaker** button. Press **+** on the **Volume** button to increase the volume, or press **-** to decrease the volume. Press **Save** (except on the Cisco SPA 501G model)

Adjusting the Ringer Volume

To adjust the ringer volume, press the **Volume** button when the handset is on the phone and the speaker button is off. Press **Save** (except on the Cisco SPA 501G model).

Using Mute

To mute the phone microphone, speaker, or headset microphone, press the **Mute** button on the phone. The button glows red. Press the **Mute** button again to unmute.

If no audio device is on, pressing the **Mute** key has no effect. When switching from the speaker phone to the handset, mute is turned off automatically.

Placing or Answering a Call

**NOTE**

You may have to dial a number or numbers to reach an outside line. Ask your phone administrator.

To place or answer a call, do one of these:

- Pick up the receiver.
- Press the **Speaker** button.

- Press the **Headset** button.
- Press a green line button (to place a call) or a red flashing line button (to answer a call). (Not applicable to the Cisco SPA 502G).

If you are on a call and another call comes in, press the flashing red line button or press the **Hold** button to place the call on hold and answer the incoming call.

To return to the first call, press the line button for the call or select it using the **Up** or **Down** navigation button and press the **Resume** softkey (Cisco SPA 502G).

Using Dial Assistance

If dial assistance is enabled, when placing calls, you'll see a list of matching recently dialed or received phone numbers on the screen after you begin dialing.



NOTE Does not apply to the Cisco SPA 501G.

If you want to choose one of these numbers:

STEP 1 Use the navigation button to scroll down and highlight a phone number on the LCD screen.

STEP 2 Press **dial** to complete the call.

See “**Enabling Dial Assistance,**” on page 52 for more information on enabling this feature.

Putting a Call on Hold

To put a call on hold, press the **Hold** button. A series of beeps or music on hold plays for the caller to indicate that the call is on hold. Only one call can be active at a time. Pressing the **Hold** button places the active call on hold.

Resuming a Call

To resume the call, press the flashing red line button for the call. (On the Cisco SPA 502G, press the **resume** softkey.)

Ending a Call

To end a call:

- If you are using the handset, hang up.
- If you are using the speakerphone, press the **Speaker** button.
- If you are using the headset, either press the **Headset** button (wired) or replace the receiver (wireless).

Transferring Calls

You can perform the following types of transfers:

- **Attended Transfer**—You call the person to whom you are transferring the call and either:
 - transfer the call while the phone is ringing.
 - wait for the person to answer before transferring the call.
- **Blind Transfer**—You transfer the call without speaking to the other party to which you are transferring the call.

Performing an Attended Transfer

Cisco SPA 502G, SPA 504G, SPA 508G, SPA 509G:

-
- STEP 1** During an active call, press **xfer**. The call is placed on hold and a new line is opened to dial the number.
- STEP 2** Either:
- Enter the number to which you want to transfer the call, then press **dial** or wait a few seconds.
 - Press **dir** and either choose a number from the personal directory or select the **Corporate Directory**, then press **dial**.
- If you hang up before the second call rings, the transfer fails and the first call is disconnected. If you misdial, use the **delChar**, **clear**, or **cancel** key (not applicable to the Cisco SPA 502G) to make your changes before the call is transferred.
- STEP 3** Press **xfer** after the phone begins to ring, or at any time after the phone is answered.

Cisco SPA 501G:

-
- STEP 1** During an active call, press the **Transfer** button.
- STEP 2** Enter the number to which you want to transfer the call.
- STEP 3** After the phone begins to ring or after the person you are calling answers, press the **Transfer** button again.
-

Performing an Unattended (Blind) Transfer

Cisco SPA 502G, SPA 504G, SPA 508G, SPA 509G:

-
- STEP 1** During an active call, press the **bXfer** softkey.
- STEP 2** Enter the number to which you want to transfer the call and press **dial**. The call is transferred with no further action required on your part.
-

Transferring a Held Call to an Active Call

**NOTE**

Does not apply to the Cisco SPA 501G.

If you have a call on hold and an active call, you can transfer one of these calls to the other call, connecting the two callers. (This differs from a conference call because you no longer remain part of the call after the transfer.)

With an active call and one or more calls on hold, press the **xferLx** softkey.

- If you have only one call on hold, the call is transferred to the active party and you are disconnected.
- If you have more than one call on hold, choose the held call you want to transfer by pressing the line button of the call on hold.

Redialing

Cisco SPA 502G, SPA 504G, SPA 508G, SPA 509G:

To redial the last number called, press the **redial** softkey twice.

To redial another number:

- STEP 1** Press the **redial** softkey and select the desired number.
- STEP 2** (Optional) Press **edit** to select a number and modify it (for example, to add an area code). When you're done, press **ok**.
- STEP 3** Lift the handset or press **dial** to automatically dial the selected number.

Cisco SPA 501G:

To redial the last number, press the **Redial** button.

Viewing and Returning Missed Calls

The LCD screen on your IP phone notifies you if a call came in that was unanswered.

**NOTE**

Does not apply to the Cisco SPA 501G.

To return a missed call:

- If the LCD screen shows a missed call, press the **lcr** softkey to return the last missed call. Press the **miss** softkey to view a list of missed calls, select a call, and press **dial**.
- If the LCD screen does not show a missed call, you can return a call from the Missed Call list:
 - a. Press the **Setup** button.
 - b. Select **Call History**.
 - c. Select **Missed Calls**.
 - d. Choose the call you want to return and press **dial**.

**NOTE**

If the call was from a long distance number, you may have to edit the call before returning it. Press the **edit** softkey to edit the call and use the softkey buttons and keypad to edit the number.

To view a list of all missed calls:

- If the LCD screen shows a missed call, press the **miss** softkey to view a list of missed calls.
- If the LCD screen does not show a missed call:
 - a. Press the **Setup** button.
 - b. Select **Call History**.
 - c. Select **Missed Calls**.

Turning the Missed Calls Shortcut On and Off

This option removes the **lcr** and **miss** softkeys that appear on the IP phone screen when you miss a call.



NOTE Does not apply to the Cisco SPA 501G.

To access this option:

- STEP 1** Press the **Setup** button.
- STEP 2** Select **Preferences**.
- STEP 3** Choose **Miss Call Shortcut** and press **edit**.
- STEP 4** Press **y/n** to enable or disable the feature.
- STEP 5** Press **ok**.
- STEP 6** Press **save**.

Forwarding Calls

You can forward all calls, forward calls when the phone is busy or forward calls when there is no answer.

You can also set call forwarding options from your PC using the IP Phone Web Interface; see the **“Configuring Call Forwarding”** section on page 69.



NOTE For the Cisco SPA 501G, you can only use the IP Phone Web Interface or star codes to set call forwarding. See the instructions below for the appropriate star codes.

Forwarding All Calls

Using the **cfwd** softkey:

-
- STEP 1** Press the **cfwd** softkey.
 - STEP 2** Enter a number to which to forward all calls; for example, your voice mailbox, another extension, or an outside line. If forwarding calls to an outside line, be sure to use any access and area codes required.
 - STEP 3** Press **dial**. The LCD screen displays Calls Forwarded.
-

Using the star code:

Press *72 and enter the number to which to forward all calls.

Using the Setup button:

-
- STEP 1** Press the **Setup** button and select **Call Forward > CFWD All Number**.
 - STEP 2** Press **edit**.
 - STEP 3** Enter a number to which to forward all calls; for example, your voice mailbox, another extension, or an outside line. If forwarding calls to an outside line, be sure to use any access and area codes required.
 - STEP 4** Press **ok**.
 - STEP 5** Press **save**.
-

Forwarding Calls When Your Phone is Busy

Using the star code:

Press *90 and enter the number to which to forward calls.

Using the Setup button:

-
- STEP 1** Press the **Setup** button and select **Call Forward > CFWD Busy Number**.
 - STEP 2** Press the **edit** softkey.

- STEP 3** Enter a number to which to forward all calls (for example, another extension, or an outside line.) If forwarding calls to an outside line, be sure to use any access and area codes required.

To enter “vm” (will connect to voice mail if this feature has been set up by your phone administrator), press the **Right** navigation button, press the **alpha** softkey, and enter letters using the keypad. Press the **Left** navigation button.

- STEP 4** Press **ok**.

- STEP 5** Press **save**.

Forwarding Calls When You Don't Answer the Phone

Using the star code:

Press *92 and enter the number to which to forward calls.

Using the Setup button:

-
- STEP 1** In the Call Forward Screen, make sure **CFWD No Ans Number** is highlighted and press the **edit** softkey.
- STEP 2** Enter “vm” for voice mail, or a number to which to forward all calls; for example, another extension, or an outside line. If forwarding calls to an outside line, be sure to use any access and area codes required.
- STEP 3** Press **ok**.
- STEP 4** Press **save**.
-

Delaying Call Forwarding When You Don't Answer the Phone

-
- STEP 1** In the Call Forward Screen, make sure **CFWD No Ans Delay** is highlighted and press the **edit** softkey.
- STEP 2** Enter the number of seconds to delay forwarding calls, if there is no answer at your phone.
-

STEP 3 Press **ok**.

STEP 4 Press **save**.

Stopping Call Forwarding

To stop forwarding calls, press the **-cfwd** softkey.

You can also stop call forwarding by pressing the **Setup** button and selecting **Call Forward > edit**. Press **clear**, then press **ok**. Press **save**.

Using star codes:

- Enter *73 to deactivate call forwarding.
- Enter *91 to deactivate call forward busy.
- Enter *93 to deactivate call forward no answer.

Setting Do Not Disturb

Use the Do Not Disturb feature to prevent incoming calls from ringing your phone. If you have voice mail configured, incoming callers immediately reach voice mail. If voice mail is not configured, callers hear a busy signal or message.

You can also set Do Not Disturb from your PC using the IP Phone Web Interface; see the **“Setting Do Not Disturb” section on page 69**.



NOTE

For the Cisco SPA 501G, you can only set Do Not Disturb in the IP Phone Web Interface or by using the star code.

Activating Do Not Disturb

Using the dnd softkey:

To activate Do Not Disturb, press the **dnd** softkey. The LCD screen indicates that Do Not Disturb is turned on for your phone.

Using the Setup button:

You can also access Do Not Disturb by performing the following steps:

-
- STEP 1** Press the **Setup** button and select **Preferences > Do Not Disturb**.
 - STEP 2** Press the **edit** softkey.
 - STEP 3** Press **y/n** to choose **y**, then press **ok**.
 - STEP 4** Press **save**.
-

Using the star code:

Enter *78 to activate Do Not Disturb.

Deactivating Do Not Disturb

Using the -dnd softkey:

To deactivate Do Not Disturb, press the **-dnd** softkey.

Using the Setup button:

You can also deactivate Do Not Disturb by pressing the **Setup** button and selecting **Preferences > Do Not Disturb**.

Using the star code:

Enter *79 to deactivate Do Not Disturb.

Turning Call Waiting On and Off

Call waiting alerts you when you are on a call by ringing your phone and displaying a status message that another call is ringing. If you turn call waiting off, incoming calls do not ring your phone if you are on another call, and the caller hears a busy signal or message.

You can also turn call waiting on and off from your PC using the IP Phone Web Interface. See the **“Configuring Call Waiting” section on page 70**.



NOTE For the Cisco SPA 501G, you can only configure Call Waiting in the IP Phone Web Interface or by using the star code.

Using the Setup button:

- STEP 1** Press the **Setup** button.
- STEP 2** Select **Preferences**.
- STEP 3** Choose **Call Waiting** and press **edit**.
- STEP 4** Press the **y/n** softkey to turn call waiting on or off.
- STEP 5** Press **ok**.
- STEP 6** Press **save**.

Using the star code:

- Enter *56 to activate call waiting.
- Enter *71 before dialing a number to activate call waiting for that call.
- Enter *57 to deactivate call waiting.
- Enter *72 before dialing a number to deactivate call waiting for that call.

Picking Up a Call

You can pick up a call that is ringing at another extension. Depending on the way your phone network is configured, you can pick up a call in the following ways:

- Pick up a call that is ringing at an extension in your group using the **grPick** softkey. (Not available for the Cisco SPA 501G.)
- Pick up a call that is ringing at specific extension using the **pickup** softkey. (Not available for the Cisco SPA 501G.)
- Pick up a call ringing at an extension that is configured on one of the line buttons on your phone. Requires configuration by your phone administrator. (Not available on Cisco SPA 502G.)

To pick up a call ringing at an extension in your group:

-
- STEP 1** Press the **grPick** softkey. The phone displays any stations in the group that have ringing calls. Press **dial** to see a list of calls.
 - STEP 2** Choose the call you want to pick up and press **dial**.
-

To pick up a call ringing at a specific extension:

-
- STEP 1** Press the **pickup** softkey.
 - STEP 2** Enter the extension number of the phone from which you are picking up the call and press **dial**.
 - STEP 3** Press **dial** again.
-

To pick up a call ringing at an extension that is configured on one of the line buttons on your phone, press the flashing line button.

Parking a Call

You can “park” a call on a designated line so that another person in your company can pick up the call. The call is active until it is “unparked” or the caller hangs up.



NOTE Not available on the Cisco SPA 501G.

To park a call:

-
- STEP 1** While on an active call, press the **park** softkey.
 - STEP 2** Enter a number to identify the park line and press **dial**. The “park line number” does not correspond with an actual phone extension number, and you can pick any easily-remembered number (for example, 100). The call is then parked on that line, and the caller hears “on hold” music or messages.
 - STEP 3** You or another person must then “unpark” the call.
-

To unpark a call, you can either use the **unpark** softkey (if you know the park line number), or view a list of parked calls and unpark it from the list.

To unpark if you know the park line number:

-
- STEP 1** Press the **unpark** softkey.
 - STEP 2** Enter the number of the park line (for example, the number that was entered in Step 2 of “parking a call.”)
 - STEP 3** Press **dial**. The call is picked up on your phone.
-

To view a list of parked calls (and unpark from the list):

-
- STEP 1** Press the **Setup** button.
 - STEP 2** Select **Call Park Status**.
 - STEP 3** Choose the parked call you want to retrieve and press **unpark**.
-

Placing a Three-Way Conference Call

You can perform conference calls by:

- calling both numbers and pressing the **conf** softkey
- conferencing an active and held call using the **confLX** softkey (not available on Cisco SPA 501G)

Cisco SPA 502G, SPA 504G, SPA 508G, SPA 509G:

To initiate a conference call:

-
- STEP 1** Press the **conf** softkey during an active call. The first call is placed on hold, a second line is opened, and you hear a dial tone.
 - STEP 2** Dial the second person's telephone number.

STEP 3 Press the **conf** softkey again. All three parties are connected in the conference call.

When you hang up, the other two parties are disconnected.

Cisco SPA 501G:

STEP 1 Press the **Conference** button during an active call. The first call is placed on hold, a second line is opened, and you hear a dial tone.

STEP 2 Dial the second person's telephone number.

STEP 3 Press the **Conference** button again. All three parties are connected in the conference call.

When you hang up, the other two parties are disconnected.

Conferencing a Held Call with an Active Call



NOTE Does not apply to the Cisco SPA 501G.

If you have a call on hold and an active call, you can create a conference call between the active call, the call on hold, and you.

With an active call and one or more calls on hold, press the **confLx** softkey.

- If you have only one call on hold, the conference call is created between the three of you.
- If you have more than one call on hold, choose the held call you want to conference in by pressing the line button of the call on hold.

Using the Phone Directories

Your IP phones provide several different types of phone directories, depending on the phone model and what the system administrator has set up for the company.

In general, the phones provide the following types of directories:

- **Personal Directory**—The personal directory provides a place for you to store and view frequently dialed numbers. You can also dial numbers from the directory.
- **Corporate Directory**—The corporate directory lists the phones and extension numbers in your company. Depending on your phone network configuration, you may have the following directories available:
 - Corporate Directory (LVS)
 - Directory using Lightweight Directory Access Protocol (LDAP)



NOTE Not available for the Cisco SPA 501G.

Using Your Personal Directory

To access the Phone Directory, press the **dir** softkey, or press the **Setup** button and select **Directory**.

You can also view and edit the directory from your PC using the IP Phone Web Interface. See the [“Using Your Personal Directory” section on page 72](#).

To add a new entry to the directory:

- STEP 1** In the Directory screen, when New Entry is selected, press the **add** softkey.
- STEP 2** Use the keypad to enter the name of the directory entry. Press the number key multiple times to move to a different letter under that number. (For example, to enter “Mary,” you would press **6** and then pause (for M); press **2** and then pause (for A), press **7** three times rapidly (for R), then press **9** three times rapidly (for Y). Use the **delChr** softkey to delete letters, the **<<<** and **>>>** softkeys to move one character to the left or the right, or the **clear** softkey to clear the entire name. When finished with the name, use the navigation button to go down to the Number field.

-
- STEP 3** Enter the phone number, including any digits you must dial to access an outside line and the appropriate area code, if necessary.
- STEP 4** (Optional) To change the ring type for the caller:
- Press the **option** softkey.
 - Scroll through the available ring types.
 - Press the **play** softkey to play the selected ring tone or the **select** softkey to assign that ringtone to the person whose number you are adding to the directory.
- STEP 5** Press **save** to save the entry.
-

Using the Corporate Directory



NOTE

Depending on your Internet Telephony Service Provider or corporate network setup, you may not have a corporate directory available to you.

To use the corporate directory:

- STEP 1** Press the **dir** softkey, or press the **Setup** button and select **Directory**.
- STEP 2** Select **Corporate Directory**.
- STEP 3** Choose an entry and press the **dial** softkey. Press **cancel** to exit.
-

To use the Lightweight Directory Access Protocol (LDAP) directory:

- STEP 1** Press the **dir** softkey, or press the **Setup** button and select **Directories**.
- STEP 2** Scroll to the **LDAP Directory Name** and press **Select**.
-



NOTE

The name of the LDAP directory is configured by the phone administrator and can differ.

STEP 3 Enter information in the fields and press **search**.

STEP 4 In the results, press **Dial** to dial the contact, or choose one of the other options.

Using the Call History Lists

You can also view the Call History Lists from your PC using the IP Phone Web Interface. See the “[Viewing Call History Lists](#)” section on page 72.



NOTE You can only view call history lists for the Cisco SPA 501G using the IP Phone Web Interface.

Viewing the Call History Lists

To view the Call History lists:

STEP 1 Press the **Setup** button.

STEP 2 Select **Call History**.

STEP 3 Select the Call History list you want to view. Available Call History lists are:

- **Redial List**—Shows the last 60 numbers dialed from your phone.
 - **Answered Calls**—Shows the caller ID of the last 60 answered calls.
 - **Missed Calls**—Shows the last 60 missed calls.
-

Calling from the Call History Lists

To dial a number from one of the Call History lists:

STEP 1 Choose the call.

STEP 2 Press **dial**.



NOTE If the call was from a long distance number, you may have to edit the call before dialing it. Press the **Edit** softkey to edit the call and use the softkey buttons and keypad to edit the number.

Deleting a Number from the Call History Lists

STEP 1 In the Redial, Answered Calls, or Missed Calls list, choose the call.

STEP 2 Press **delete**.

STEP 3 Press **OK**.

Saving a Call History List Number to Your Directory

STEP 1 In the Redial, Answered Calls, or Missed Calls list, choose the call.

STEP 2 Use the navigation button to scroll to the right to access more softkey button options, and press **save**.

STEP 3 Edit the information (if desired) and press **save** again. The entry is added to your directory.

Setting or Changing a Phone Password

You can set or change the password for your phone to prevent unauthorized use. To set a password for your phone:

-
- STEP 1** Press the **Setup** button.
 - STEP 2** Select **Set Password**.
 - STEP 3** Enter a numeric password. Enter the same password twice.
 - STEP 4** Press **save**.
-

Accessing Voicemail

To access voicemail, press the **Messages** button on your phone. Your system administrator should configure your phone with the correct voicemail number so that pressing the **Messages** button automatically dials your voicemail system.

If you need to change the number for your voicemail (for example, if your phone is not part of a Cisco SPA 9000 Voice System and you have external voicemail), perform the following steps:

-
- STEP 1** Press the **Setup** button.
 - STEP 2** Scroll to **Voice Mail** and press **select**.
 - STEP 3** Enter the number to dial for voicemail. For a Cisco SPA 9000 Voice System, this is normally “vmm.” For an external system, enter the phone number, including any digits you must dial to reach an outside line.



TIP To clear the field of a previous entry, press **clear**. To enter letters, press the **Right** navigation button to scroll, then press the **alpha** softkey.

- STEP 4** Press **save**.
-

Using Advanced Phone Features

This chapter describes how to configure advanced features on your IP Phone. It contains the following sections:

- **Configuring Privacy and Security Features, page 50**
- **Creating Speed Dials, page 52**
- **Using Speed Dials, page 54**
- **Using the Paging Feature, page 54**
- **Monitoring/Accessing Another Phone from Your Phone, page 55**
- **Customizing Your LCD Screen, page 56**
- **Using Ring Tones, page 59**
- **Configuring Date and Time Parameters on Your Phone, page 60**
- **Using Star Codes, page 60**
- **Using the Interactive Voice Response Menu on the Cisco SPA 501G, page 62**
- **Advanced Procedures for Technical Support Personnel, page 65**

Configuring Privacy and Security Features

You can also configure these features using your PC and the IP Phone Web Interface. See “**Blocking Caller ID,**” on page 71 and the “**Blocking Anonymous Calls,**” on page 71.



NOTE For the Cisco SPA 501G, configure these features using the IP Phone Web Interface or use the star codes (described below).

Blocking Caller ID

You can block Caller ID from your phone so that your phone number will not appear to the person you call.

Using the Setup button:

-
- STEP 1** Press the **Setup** button.
 - STEP 2** Select **Preferences**.
 - STEP 3** Choose **Block Caller ID** and press **edit**.
 - STEP 4** Press **y/n** to choose **yes**.
 - STEP 5** Press **ok**.
 - STEP 6** Press **save**.
-

Using the star code:

Press ***67** before dialing the number. (Caller ID blocking will remain enabled until you enter ***68**.)

Blocking Anonymous Calls

Blocking anonymous calls prevents calls with unknown Caller ID from ringing your phone. (For example, if a caller set his phone to not display Caller ID, the call is considered anonymous.) These callers receive a busy signal or message.

Using the Setup button:

- STEP 1** Press the **Setup** button.
 - STEP 2** Select **Preferences**.
 - STEP 3** Choose **Block Anonymous Call** and press **edit**.
 - STEP 4** Press **y/n** to choose **yes**.
 - STEP 5** Press **ok**.
 - STEP 6** Press **save**.
-

Using the star code:

Press ***77**. Anonymous call rejection will be enabled until you enter ***87**.

Using Secure Call

With the secure call feature, the active call is encrypted so that others cannot eavesdrop. Before enabling Secure Call, ask your service provider if Secure Call is available.

Using the **Setup** button (not applicable to Cisco SPA 501G):

- STEP 1** Press the **Setup** button.
 - STEP 2** Select **Preferences**.
 - STEP 3** Choose **Secure Call** and press **edit**.
 - STEP 4** Press **y/n** to choose **yes**.
 - STEP 5** Press **ok**.
 - STEP 6** Press **save**. When you dial, you will hear a tone before the call.
-

Using star codes:

- ***16**—Activate Secure Call feature for all calls.
- ***18**—Activate Secure Call feature for a single call.

To deactivate secure call:

- ***17**—Deactivate Secure Call feature for all calls.
- ***19**—Deactivate Secure Call feature for a single call.

Enabling Dial Assistance

If you enable dial assistance, when you place calls, the LCD will display phone numbers based on the best matched entries in the Directory and Call History lists.



NOTE Dial assistance is not available on the Cisco SPA 501G.

To enable dial assistance:

- STEP 1** Press the **Setup** button.
- STEP 2** Select **Preferences**.
- STEP 3** Choose **Dial Preferences** and press **edit**.
- STEP 4** Press **y/n** to choose **yes**.
- STEP 5** Press **ok**.
- STEP 6** Press **save**.

If dial assistance is enabled, when placing calls, use the navigation button to scroll down, highlight a phone number on the LCD screen, and press **dial** to complete the call.

Creating Speed Dials

You can configure different types of speed dials:

- You can assigned unused line buttons on your phone to act as a speed dial.

- Depending on how your extensions are configured and how many line buttons are on your phone, you can have up to 7 speed dials on the line buttons.
- You can create speed dials assigned to a number, that, when pressed on the keypad, dials the number assigned to it. You can have up to 8 of these speed dials. Each speed dial can be a phone number, IP address or URL.

You can create and edit speed dials using your PC and the IP Phone Web Interface. See “[Creating Speed Dials](#),” on page 73.



NOTE For the Cisco SPA 501G, create speed dials using the IP Phone Web Interface.

Creating Speed Dials on Unused Line Buttons

- STEP 1** Press the unused line button and hold down for three seconds. The **Define Speed Dial window** displays.
- STEP 2** Enter the name for the speed dial.
- STEP 3** Press the **Down Arrow** key to reach the phone number field. Enter the phone number and press **Save**.
- STEP 4** After creating the speed dial, it displays next to the line button. Press the line button to use the speed dial.



NOTE For the Cisco SPA 501G or Cisco SPA 502G, your phone administrator can use the web interface to create speed dials on unused line buttons. This is an administrative function available from the **Admin > Advanced Configuration** pages.

Creating Numerical Speed Dials

- STEP 1** Press the **Setup** button.
- STEP 2** Select **Speed Dial**.

-
- STEP 3** For a new speed dial, scroll to select an unused speed dial (marked with Not Assigned). To edit a previously existing speed dial, select it.
- STEP 4** Press **edit**.
- STEP 5** Enter the number to assign to the speed dial and press **ok**.
-

Using Speed Dials

Cisco SPA 502G, SPA 504G, SPA 508G, SPA 509G:

To call one of your configured speed dial numbers, either:

- Open a phone line and press the number on the phone keypad for the speed dial, then press **Dial**.
- Press the **Setup** button, select **Speed Dial**, choose the number, and press **Dial**.

Cisco SPA 504G, SPA508G, SPA509G:

Press the unused line button you have configured for a speed dial.

Cisco SPA 501G:

Press the number on the phone keypad for the speed dial and wait a few seconds.

Using the Paging Feature

Your IP phone can automatically answer pages from other Cisco IP phones in the Cisco SPA 9000 Voice System. When your phone is paged, the phone emits a series of beeps, and two-way audio is established between your phone and the phone that called you. You do not have to accept the page.



NOTE

Your phone must be part of a Cisco SPA 9000 Voice Network to use this feature.

Paging Another Phone

To page another phone, dial ***96** plus the extension of the phone you are paging. If the phone you are paging is not set up to auto answer pages, the call will ring as a normal voice call.

Paging a Group of Phones

Your phone administrator can configure a group of phones that you can page simultaneously. Each paging group has a number associated with it. Your administrator must give you the number of the groups that are configured. To page this group, dial ***96** plus the number of the paging group.

Configuring Auto Answer

To configure your phone to auto answer pages:

-
- STEP 1** Press the **Setup** button.
 - STEP 2** Select **Preferences**.
 - STEP 3** Choose **Auto Answer Page** and press **edit**.
 - STEP 4** Press **y/n** to choose **yes**.
 - STEP 5** Press **ok**.
 - STEP 6** Press **save**.
-

Monitoring/Accessing Another Phone from Your Phone

Your system administrator may configure your phone so that you can monitor other user's phones from your phone. If this feature is configured, some line buttons on your phone are assigned to display the status of another user's phone. For example, if your line 4 is configured to display Bob's phone line, the LED color shows you the status of his phone line:

- **Green:** Line is idle.
- **Red (steady):** Line is active or in use.

- **Red** (blinking): Line is ringing.
- **Orange** (solid): Line is unregistered (cannot be used).
- **Orange** (blinking): Line is not configured properly.

In addition, if your system administrator has configured it, you can press the same line button (4) to speed dial Bob's extension, or to pick up a ringing call at his extension.



NOTE Not applicable to the Cisco SPA 502G.

Customizing Your LCD Screen



NOTE Not available on the Cisco SPA 501G.

You can customize your LCD screen in several ways.

Changing the LCD Screen Contrast

You can also change your LCD screen contrast from your PC using the IP Phone Web Interface. See [“Changing the LCD Contrast,” on page 75](#).

To adjust the contrast of the LCD screen:

- STEP 1** Press the **Setup** button, scroll to highlight **LCD Contrast**, and press the **select** button.
- STEP 2** Use the navigation button to adjust the screen contrast. Pressing the **Left** navigation button decreases the contrast. Pressing the **Right** navigation button increases the contrast.
- STEP 3** Press **save**.

Changing the Screen Backlight Settings

The screen backlight turns off after a specified period of time. You can change this time period so that the screen backlight is on for a longer period, or keep the backlight always on.

-
- STEP 1** Press the **Setup** button.
 - STEP 2** Select **Preferences**.
 - STEP 3** Choose **Back Light Timer** and press **edit**.
 - STEP 4** Press Option to choose the desired setting:
 - 10 seconds
 - 20 seconds
 - 30 seconds
 - always on
 - STEP 5** Press **ok**.
 - STEP 6** Press **save**.
-

Configuring the Phone Screen Saver

You can enable your phone's screen saver and specify its appearance and the amount of time for the phone to be idle before it begins. Some of these options can be configured from your PC using the IP Phone Web Interface. See **“Configuring the Phone Screen Saver,” on page 75**.

To configure your screen saver:

-
- STEP 1** Press the **Setup** button.
 - STEP 2** Select **Screen Saver Mode**.
-

To enable your screen saver:

-
- STEP 1** In **Screen Saver Mode**, choose **Enable Screen Saver** and press **edit**.
 - STEP 2** Press **y/n** to choose **yes**.
 - STEP 3** Press **ok**.
 - STEP 4** Press **save**.
-

To specify the amount of time before the screen saver turns on if your phone is idle:

-
- STEP 1** In **Screen Saver Mode**, choose **Screen Saver Wait Time** and press **edit**.
 - STEP 2** Enter the time, in seconds, to wait before the screen saver starts.
 - STEP 3** Press **ok**.
 - STEP 4** Press **save**.
-

To change your screen saver picture:

-
- STEP 1** In **Screen Saver Mode**, choose **Screen Saver Icon** and press **edit**.
 - STEP 2** Press **option** multiple times to display the choices available until the one you want is displayed. Options are:
 - **Background Picture**—Displays your phone's background picture.
 - **Station Time**—Overlays the phone's station ID and time onto the picture.
 - **Lock**—Overlays a lock graphic onto the picture.
 - **Phone**—Overlays a phone graphic onto the picture.
 - **Date/Time**—Overlays the date and time onto the picture.
 - STEP 3** Press **ok**.
 - STEP 4** Press **save**.
-

Turning on the Screen Saver

To immediately turn on your phone's screen saver:

-
- STEP 1** Press the **Setup** button.
 - STEP 2** Scroll to **Screen Saver Mode** and press **activ.** (The screen saver must be enabled in order to immediately activate it.)
-

Using Ring Tones



NOTE Not available on the Cisco SPA 501G.

Each extension of your phone can have a different ring tone. You can also create your own ring tones.

Changing Your Ring Tone

To change a ring tone:

-
- STEP 1** Press the **Setup** button.
 - STEP 2** Select **Ring Tone**.
 - STEP 3** Choose the extension for which to choose a ring tone and press **change**.
 - STEP 4** Scroll through the ring tones and press **play** to play the highlighted ring tone. Press **select** to choose the highlighted ringtone for that extension.
-

Configuring Date and Time Parameters on Your Phone

Setting Your Phone's Date and Time

The date and time for your phone normally come from the SIP proxy server or NTP server. However, if you need to change some date and time parameters, you can follow these steps:

-
- STEP 1** Press the **Setup** button.
 - STEP 2** Select **Time/Date**.
 - STEP 3** Enter the date in the following format: mm*dd*yy (this will display as m/d).
 - STEP 4** Enter the time in the following format: hh*mm*ss (this will display as (h:mm)).
 - STEP 5** If the time does not display am (a) or pm (p) correctly, adjust with Offset. To change from a.m. to p.m., enter *12*00*00, to change from p.m. to a.m., enter #12*00*00.
 - STEP 6** Press **save**.

You can set just one of these choices, if necessary.

Using Star Codes

Your IP phone can support numerous “star codes” to access phone supplementary services. These codes, which start with *, are entered before dialing a telephone number and provide services. For example, to block caller ID (star code 67), you would dial *67, followed by the telephone number you are calling.

Following is a list of commonly-used star codes. Some star codes may not be available to you; consult your system administrator for more information.

Code	Definition
16	Activate Secure Call feature for all calls.* See Using Secure Call, page 51 .
17	Deactivate Secure Call feature for all calls.* See Using Secure Call, page 51 .
18	Activate Secure Call feature for a single call.* See Using Secure Call, page 51 .
19	Deactivate Secure Call feature for a single call.* See Using Secure Call, page 51 .
36	Pick up a call at another extension.* See Picking Up a Call, page 40 .
37	Pick up a group call.* See Picking Up a Call, page 40 .
38	Park a call.* See Parking a Call, page 41 .
39	Unpark a call.* See Parking a Call, page 41 .
56	Activate call waiting. See Turning Call Waiting On and Off, page 39 .
57	Deactivate call waiting. See Turning Call Waiting On and Off, page 39 .
66	Activate Call Back. Causes the IP phone to repeatedly dial a busy number until the called party rings or answers. The IP phone then alerts you that the call has gone through.
67	Block Caller ID. See Blocking Caller ID, page 50 .
68	Unblock Caller ID. See Blocking Caller ID, page 50 .
69	Calls the last number that called your phone.
70	Deactivate call waiting for a single call. See Turning Call Waiting On and Off, page 39 .
71	Activate call waiting for a single call. See Turning Call Waiting On and Off, page 39 .
72	Activate Call Forward All. See Forwarding Calls, page 35 .
73	Deactivate Call Forward All. See Forwarding Calls, page 35 .
77	Activate anonymous call blocking. See Blocking Anonymous Calls, page 50 .

Code	Definition
78	Activate Do Not Disturb. See Setting Do Not Disturb, page 38 .
79	Deactivate Do Not Disturb. See Setting Do Not Disturb, page 38 .
86	Deactivate Call Back.
87	Deactivate anonymous call blocking. See Blocking Anonymous Calls, page 50 .
90	Activate Call Forward Busy. See Forwarding Calls, page 35 .
91	Deactivate Call Forward Busy. See Forwarding Calls, page 35 .
92	Activate Call Forward No Answer. See Forwarding Calls, page 35 .
93	Deactivate Call Forward No Answer. See Forwarding Calls, page 35 .
96	Page an extension.** See Using the Paging Feature, page 54 .
98	Perform a blind transfer. Transferring Calls, page 31 .

*Requires that your IP phone be part of a Cisco SPA 9000 Voice System network.

**Requires that the paged extension be part of a Cisco SPA 9000 Voice System network.

Using the Interactive Voice Response Menu on the Cisco SPA 501G

The Cisco SPA 501G provides an interactive voice response menu. You can enter options and receive information about the phone and its operation.

To access the IVR:

STEP 1 Press the **Setup** button.

Enter the IVR option by pressing the numbers of the option, then press **#**. Some menus require entering of further information or numbers.

Typical options you might use are listed in the following table:

Number	Option
100	Tells you if Dynamic Host Configuration Protocol (DHCP) is enabled.
110	Recites the IP address of the phone.
120	Recites the netmask of the phone.
130	Recites the gateway address.
140	Recites the MAC (hardware) address of the phone.
150	Recites the phone software version.
160	Recites the primary DNS server address.
170	Recites the HTTP port on which the web server listens. Defaults to 80.
180	Recites the IP multicast address (used by the Cisco SPA 9000 to communicate with the IP phone).
220	Recites the method of call control (SIP or SPCP).
221	<p>Set call control—enter the value for the call control method you want, then press #:</p> <ul style="list-style-type: none"> ▪ 0: SIP ▪ 1: SPCP <p>To save, press 1; to review, press 2; to re-enter, press 3; to exit, press *.</p>
73738	<p>Restore the phone to the factory default software and settings.</p> <p>Enter 1 to confirm, or * to exit. If you chose to reset, hang up to exit and begin the restore process.</p>
87778	<p>Restore the phone's user settings to the default. (Clears all user settings such as speed dials.)</p> <p>Enter 1 to confirm, or * to exit. If you chose to reset, hang up to exit and begin the restore process.</p>
732668	Reboot the phone. After entering # , hang up to begin rebooting.

Number	Option
111	<p>Set a static IP address. Enter the address (use * to enter the "." value), then press #.</p> <p>To save, press 1; to review, press 2; to re-enter, press 3; to exit, press *.</p> <p>NOTE DHCP must be disabled to use this option; if DHCP is not disabled, you receive an error message.</p>
121	<p>Set a netmask. Enter the address (use * to enter the "." value), then press #.</p> <p>To save, press 1; to review, press 2; to re-enter, press 3; to exit, press *.</p> <p>NOTE DHCP must be disabled to use this option; if DHCP is not disabled, you receive an error message.</p>
131	<p>Set a gateway. Enter the address (use * to enter the "." value), then press #.</p> <p>To save, press 1; to review, press 2; to re-enter, press 3; to exit, press *.</p> <p>NOTE DHCP must be disabled to use this option; if DHCP is not disabled, you receive an error message.</p>
161	<p>Set the address of the primary Domain Name Server (DNS). Enter the address (use * to enter the "." value), then press #.</p> <p>To save, press 1; to review, press 2; to re-enter, press 3; to exit, press *.</p>
181	<p>Set the IP multicast address (used by the Cisco SPA 9000 to communicate with the IP phone). Enter the address (use * to enter the "." value), then press #.</p> <p>To save, press 1. To review the value you entered, press 2. To re-enter, press 3. To exit, press *.</p>
7932	<p>Enable or disable the web server. Press 1 to enable or 0 to disable, then press #.</p> <p>To save, press 1; to review, press 2; to re-enter, press 3; to exit, press *.</p>
723646	<p>Enable or disables access to the administrative (admin) login on the web interface. Press 1 to enable or 0 to disable, then press #.</p> <p>To save, press 1; to review, press 2; to re-enter, press 3; to exit, press *.</p>

Advanced Procedures for Technical Support Personnel



CAUTION These menus are used to configure and troubleshoot your phone and the phone network. You should not change these settings or perform these actions unless directed to do so by your phone administrator.

To access advanced menus on the Cisco SPA 502G, SPA 504G, SPA 508G, and SPA 509G, follow the procedures below. For the Cisco SPA 501G, many of these options can be performed in the IVR. See the [“Using the Interactive Voice Response Menu on the Cisco SPA 501G” section on page 62](#).

STEP 1 Press the **Setup** button.

STEP 2 Choose from the following options:

- **Network:** This setting is to configure and troubleshoot the network. You should not change this settings unless directed to by your Administrator as this can seriously alter your phone’s functions.
- **Product Info:** This setting displays the product name, serial number, software version, hardware version, MAC address and Client Certificate.
- **Status:** This setting displays the status of the phone, extension and line buttons.
- **Reboot:** See [Rebooting Your Phone, page 66](#).
- **Restart:** Restarts your phone.
- **Factory Reset:** Resets your phone to the factory default settings.



CAUTION If you choose factory reset, you will return the phone to the original factory settings and will erase *all* current settings, including the directory and call logs. It is also possible that your phone extension will change.

- Custom Reset: Resets your phone to the latest customization profiles.
- Language: Changes the language on your phone (subject to availability and configuration by your system administrator).

Rebooting Your Phone

This setting is to configure and troubleshoot the network. You should not change this settings unless directed to by your phone administrator as this can negatively affect your phone's function.

To reboot your phone:

Cisco SPA 502G, SPA 504G, SPA 508G, SPA 509:

-
- STEP 1** Press the **Setup** button.
 - STEP 2** Scroll to **Reboot** and press **select**.
 - STEP 3** Press **ok**.

Cisco SPA 501G:

-
- STEP 1** Press the **Setup** button.
 - STEP 2** At the IVR menu, enter 732668, then press #.
 - STEP 3** Hang up to begin the reboot.
-

Using the Web Interface

Your Cisco IP Phone provides a web interface to the phone that allows you to configure some features of your phone using a web browser. This chapter contains the following sections:

- [Logging in to the Web Interface, page 68](#)
- [Setting Do Not Disturb, page 69](#)
- [Configuring Call Forwarding, page 69](#)
- [Configuring Call Waiting, page 70](#)
- [Blocking Caller ID, page 71](#)
- [Blocking Anonymous Calls, page 71](#)
- [Using Your Personal Directory, page 72](#)
- [Viewing Call History Lists, page 72](#)
- [Creating Speed Dials, page 73](#)
- [Accepting Text Messages, page 73](#)
- [Adjusting Audio Volume, page 74](#)
- [Changing the LCD Contrast, page 75](#)
- [Configuring the Phone Screen Saver, page 75](#)

Logging in to the Web Interface

STEP 1 Get the IP address of your phone:

Cisco SPA 502G, SPA 504G, SPA 508G, SPA 509G:

- a. Press the **Setup** button.
- b. Scroll to **network** and press **select**.
- c. Scroll to view **Current IP**. This is the IP address of your phone.

Cisco SPA 501G:

- a. Press the **Setup** button.
- b. Enter **110**, then press **#**. The IP address is recited.

STEP 2 On your PC, open Internet Explorer.

STEP 3 Enter the IP address in the browser's toolbar.

The web interface has four main tabs:

- **Voice**—Contains information about your phone, including the following sub-tabs:
 - **Info**—Contains system and phone information (read only).
 - **System**—Allows you to configure a password and network settings.
 - **Phone**—Allows you to enable the screen saver.
 - **User**—Contains settings for call forwarding, speed dials, call waiting, privacy settings, and audio settings.
- **Call History**—Displays calls received and made from your phone.
- **Personal Directory**—Contains your personal address book.
- **Attendant Console Status**—Provides information about Cisco SPA 500S attendant consoles, if installed.

Setting Do Not Disturb

Use the Do Not Disturb feature to prevent incoming calls from ringing your phone. If you have voice mail configured, incoming callers immediately reach voice mail. If voice mail is not configured, callers hear a busy signal or message.

To set Do Not Disturb:

-
- STEP 1** Log in to the web interface.
 - STEP 2** In the **Voice** tab, click the **User** tab.
 - STEP 3** Under **Supplementary Services**, locate the **Do Not Disturb** field.
 - STEP 4** Choose **Yes** to turn on **Do Not Disturb**.
 - STEP 5** At the bottom of the page, click **Submit All Changes**.



NOTE You can turn off Do Not Disturb from your phone or from the web interface.

Configuring Call Forwarding

-
- STEP 1** Log in to the web interface.
 - STEP 2** In the **Voice** tab, click the **User** tab.

STEP 3 Under **Call Forward**, you can configure the following fields:

- **CFWD All Dest**—Forwards all calls to a single number that you enter.
- **CFWD Busy Dest**—Forwards all calls to another number when the phone is busy. Enter the number to which to forward calls.
- **CFWD No Ans Dest**—Forwards calls to another number if there's no answer at your phone. Enter the number to which to forward calls.
- **CFWD No Ans Delay**—Number of seconds to delay forwarding calls, if there is no answer at your phone. Enter the number of seconds to delay.

STEP 4 At the bottom of the page, click **Submit All Changes**.

Configuring Call Waiting

Call waiting alerts you when you are on a call by ringing and displaying a status message that you have another incoming call. If you turn call waiting off, incoming calls do not ring your phone if you are on another call, and the caller hears a busy signal or message.

To turn call waiting on or off:

STEP 1 Log in to the web interface.

STEP 2 In the **Voice** tab, click the **User** tab.

STEP 3 Under **Supplementary Services**, locate the **CW Setting** field.

STEP 4 Choose **yes** or **no** to enable or disable.

STEP 5 At the bottom of the page, click **Submit All Changes**.

Blocking Caller ID

You can block Caller ID from your phone so that your phone number will not appear to the person you call.

To block Caller ID:

-
- STEP 1** Log in to the web interface.
 - STEP 2** In the **Voice** tab, click the **User** tab.
 - STEP 3** Under **Supplementary Services**, locate the **Block CID Setting** field.
 - STEP 4** Choose **yes** or **no** to enable or disable.
 - STEP 5** At the bottom of the page, click **Submit All Changes**.
-

Blocking Anonymous Calls

Blocking anonymous calls prevents calls with unknown Caller ID from ringing your phone. (For example, if a caller set his phone to not display Caller ID, the call is considered anonymous.) These callers receive a busy signal or message.

To block anonymous calls:

-
- STEP 1** Log in to the web interface.
 - STEP 2** In the **Voice** tab, click the **User** tab.
 - STEP 3** Under **Supplementary Services**, locate the **Block ANC Setting** field.
 - STEP 4** Choose **yes** or **no** to enable or disable.
 - STEP 5** At the bottom of the page, click **Submit All Changes**.
-

Using Your Personal Directory

Your IP phone provides a phone directory for you to store and view frequently dialed numbers. This directory appears on your phone, and you can dial numbers from the directory.



NOTE Does not apply to the Cisco SPA 501G.

To view and edit your personal directory:

STEP 1 Log in to the web interface.

STEP 2 Click the **Personal Directory** tab. A window appears with the Personal Directory listings for your phone.

To enter a new item into the directory:

STEP 1 select the line and enter the information in the following format:

n=Marketing;p=5045551212

where “n=” indicates the name for the entry and “p=” indicates the phone number (including area code).

STEP 2 At the bottom of the page, click **Submit Changes**.

Viewing Call History Lists

To view Call History Lists:

STEP 1 Log in to the web interface.

STEP 2 Click the **Call History** tab. A window appears with the call history lists for your phone. These include:

- **Placed**—Shows the last 60 numbers dialed from your phone.
- **Answered**—Shows the caller ID of the last 60 answered calls.

- **Missed**—Shows the last 60 missed calls.

Click the tab for each list to view it.

Creating Speed Dials

You can configure up to 8 speed dials for the number keys. Each speed dial can be a phone number, IP address or URL.

To create or edit a numerical speed dial:

-
- STEP 1** Log in to the web interface.
 - STEP 2** In the **Voice** tab, click the **User** tab.
 - STEP 3** Under **Speed Dial**, enter the speed dial numbers you want to create or edit.
 - STEP 4** Click **Submit All Changes**.
-

Accepting Text Messages

Your phone can accept text messages from some IP phones or services.

To accept text messages from other IP phones:

-
- STEP 1** Log in to the web interface.
 - STEP 2** In the **Voice** tab, click the **User** tab.
 - STEP 3** Under **Supplementary Services**, in the **Text Message** field, choose **yes**.
 - STEP 4** Click **Submit All Changes**.
-

To accept text messages from a third party:

-
- STEP 1** Log in to the web interface.
 - STEP 2** In the **Voice** tab, click the **User** tab.
 - STEP 3** Under **Supplementary Services**, in the **Text Message from 3d Party** field, choose **yes**.
 - STEP 4** Click **Submit All Changes**.
-

Adjusting Audio Volume

-
- STEP 1** Log in to the web interface.
 - STEP 2** In the **Voice** tab, click the **User** tab.

Under **Audio Volume**, you can adjust the following settings:

- Ringer Volume
- Speaker Volume
- Handset Volume
- Headset Volume

Enter a volume between 1 and 10, with 1 being the lowest.

- STEP 3** Click **Submit All Changes**.
-

Changing the LCD Contrast



NOTE Not applicable to the Cisco SPA 501G.

STEP 1 Log in to the web interface.

STEP 2 In the **Voice** tab, click the **User** tab.

STEP 3 Under **Audio Volume**, you can adjust the LCD contrast by entering a number between 1 and 10, with 1 being low contrast.

STEP 4 Click **Submit All Changes**.

Configuring the Phone Screen Saver



NOTE Not applicable to the Cisco SPA 501G.

To configure the phone screen saver:

STEP 1 Log in to the web interface.

STEP 2 In the **Voice** tab, click the **Phone** tab.

Under **General**, you can configure the following:

- **Screen Saver Enable:** Turns the screen saver on and off.
- **Screen Saver Wait:** The number of seconds that the phone is idle before the screen saver starts.
- **Screen Saver Icon:** The display type:
 - A background picture.
 - The station time in the middle of the screen.

-
- A moving padlock icon. When the phone is locked, the status line displays a scrolling message “Press any key to unlock your phone.”
 - A moving phone icon.
 - The station date and time in the middle of the screen.

STEP 3 Click **Submit All Changes**.

Using the Cisco SPA 500S Attendant Console

This chapter describes how to install and use the Cisco SPA 500S Attendant Console with your IP Phone.

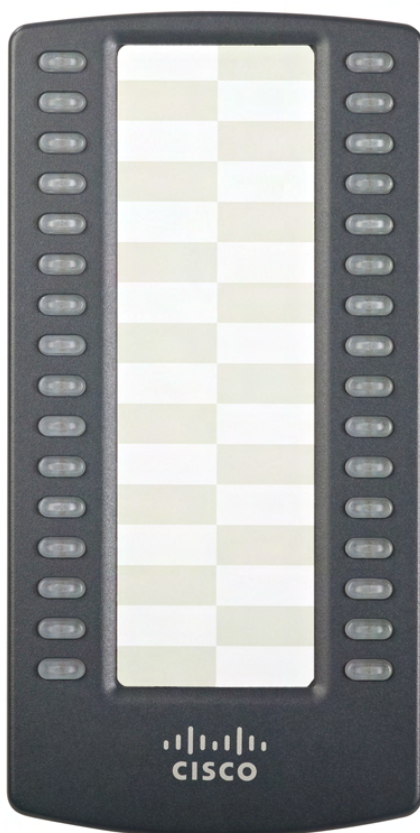

Figure 1 Cisco SPA 500S Attendant Console

The Cisco SPA 500S is a 32-button attendant console for the Cisco SPA 500 Series IP Phones, providing 32 three-color (red, green, and orange) programmable LEDs, with support for Broadsoft Busy Lamp Field and Asterisk Line Monitoring. The Cisco SPA 500S attaches to the IP phone with the attachment arm provided. It obtains power directly from the IP phone and does not require a separate power supply. Two Cisco SPA 500S units can be attached to a single IP phone to monitor a total of 64 separate lines.

Connecting the Cisco SPA 500S Attendant Console to the IP Phone

To connect the Cisco SPA 500S Attendant Console to the IP phone, you need the following:

- Cisco SPA 500S Attendant Console
- Attachment Arm
- Two (2) Attachment Arm Screws
- Auxiliary Interconnect Cable
- Stand

Connecting a Single Cisco SPA 500S

- STEP 1** Turn both the IP phone and Cisco SPA 500S face down.
- STEP 2** Align the screw hole in the IP phone with one of the holes on the attachment arm.
- STEP 3** Insert the pegs on the attachment arm into the peg holes on the IP phone.

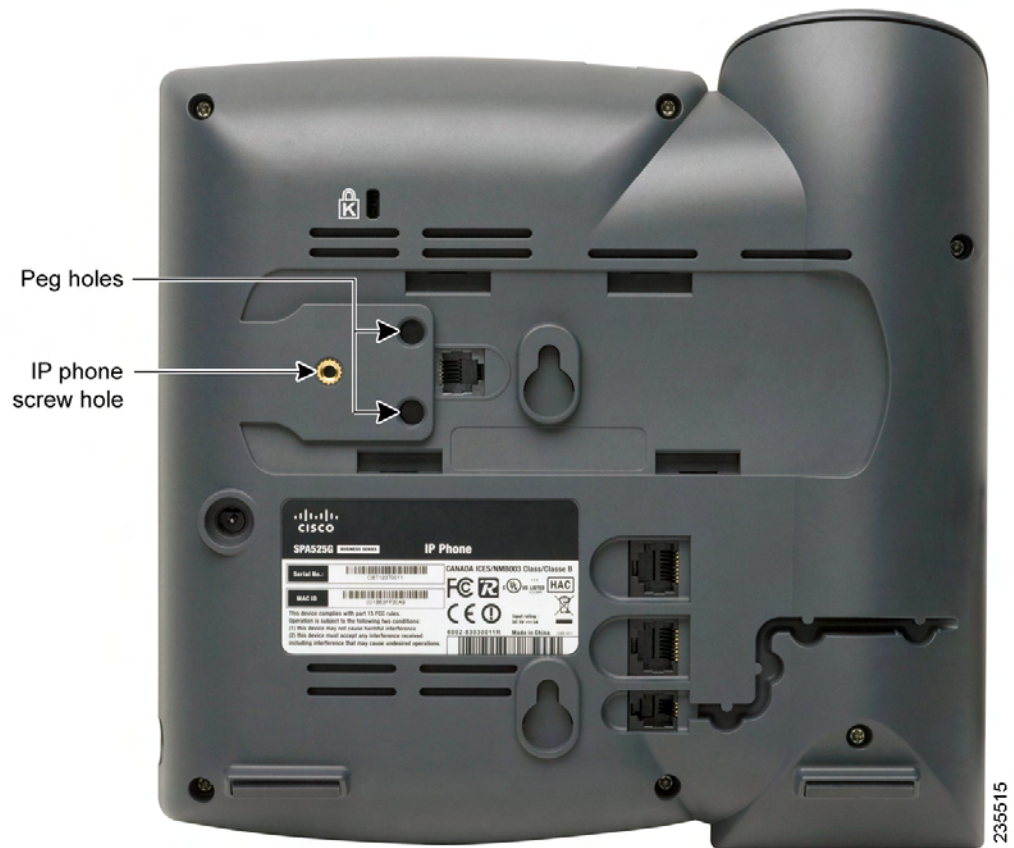

Using the Cisco SPA 500S Attendant Console

Connecting the Cisco SPA 500S Attendant Console to the IP Phone

6

- STEP 4** Using an attachment arm screw, secure the attachment arm to the IP phone.
- STEP 5** Align the right screw hole in the Cisco SPA 500S with the unused hole on the attachment arm.
- STEP 6** Insert the pegs on the attachment arm into the peg holes on the Cisco SPA 500S.



STEP 7 Using an attachment arm screw, secure the attachment arm to the Cisco SPA 500S.

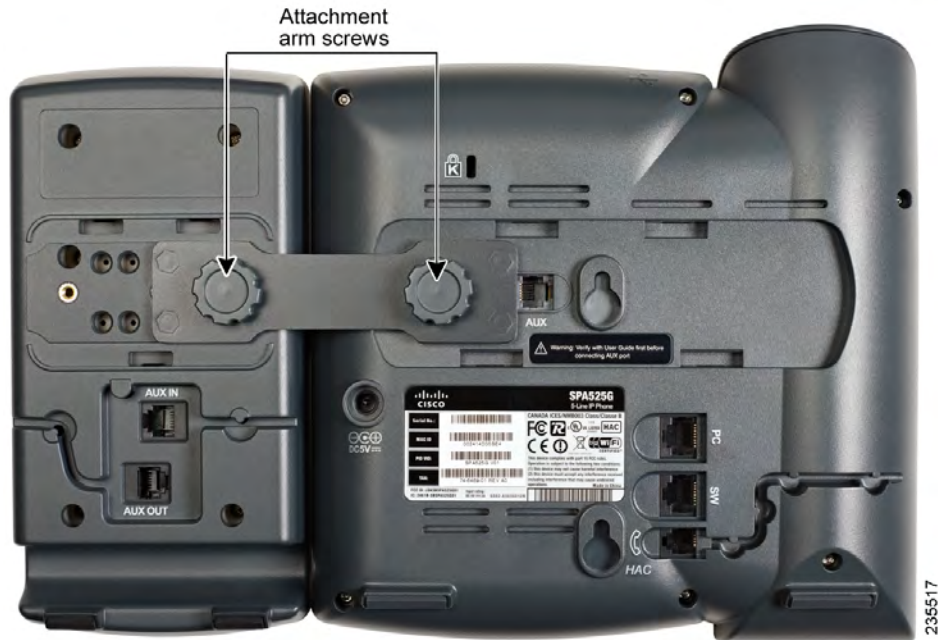

CAUTION Do not plug a telephone line cord into the AUX port. Use only the auxiliary cable provided with the Cisco SPA 500S.

STEP 8 Locate the AUX IN port on the back of the Cisco SPA 500S. Connect one end of the auxiliary cable to this port.

STEP 9 Locate the AUX port on the back of the IP phone. Connect the other end of the auxiliary cable to this port. The Cisco SPA 500S is powered by the auxiliary cable with the IP phone; no additional power source is required.

STEP 10 Route the auxiliary cable inside the cable slot of the Cisco SPA 500S.

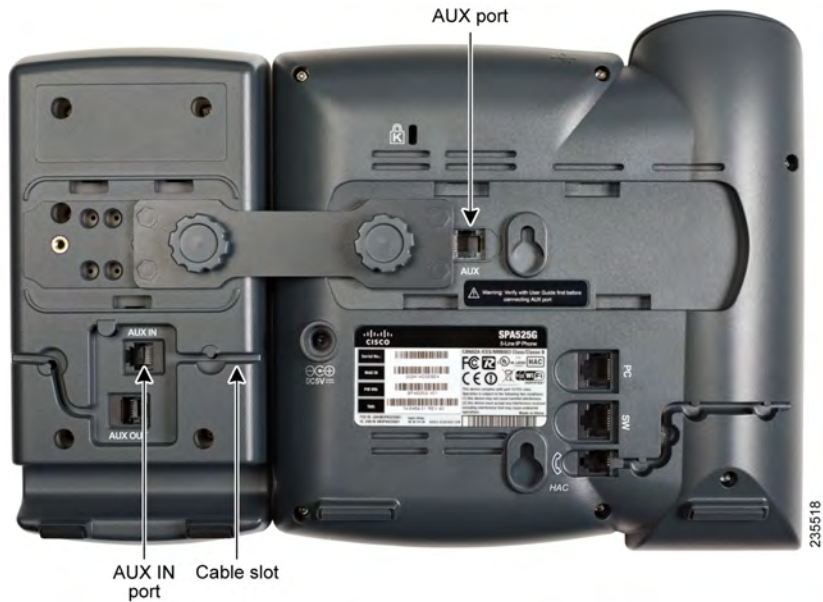

STEP 11 Attach the appropriate desktop stand to each unit.



Connecting a Second Cisco SPA 500S

A maximum of two SPA500S attendant consoles can be connected to a Cisco SPA 500 Series IP Phone. The instructions in this section are for connecting a second Cisco SPA 500S. If you are not attaching a second Cisco SPA 500S, skip to **“Configuring the Cisco SPA 500S” on page 85.**

- STEP 1** Attach the first Cisco SPA 500S to the IP phone and connect the auxiliary cable as described in the **“Connecting the Cisco SPA 500S Attendant Console to the IP Phone” section on page 78.**
- STEP 2** Align the left screw hole in the first Cisco SPA 500S with one of the holes on the attachment arm.



- STEP 3** Insert the pegs on the attachment arm into the peg holes on the Cisco SPA 500S.
- STEP 4** Using the attachment arm screw, secure the attachment arm to the first Cisco SPA 500S.
- STEP 5** Insert the pegs on the attachment arm into the peg holes on the Cisco SPA 500S.
- STEP 6** Using the attachment arm screw, secure the attachment arm to the second Cisco SPA 500S.



CAUTION Do not plug a telephone line cord into the AUX port. Use only the auxiliary cable provided with the Cisco SPA 500S.

- STEP 7** Locate the AUX OUT port on the back of the first Cisco SPA 500S. Connect one end of the auxiliary cable to this port.
- STEP 8** Locate the AUX IN port on the back of the second Cisco SPA 500S. Connect the other end of the auxiliary cable to this port.
- STEP 9** Route the auxiliary cable inside the cable slot. The Cisco SPA 500S is powered by the auxiliary cable with the IP phone; no additional power source is required.

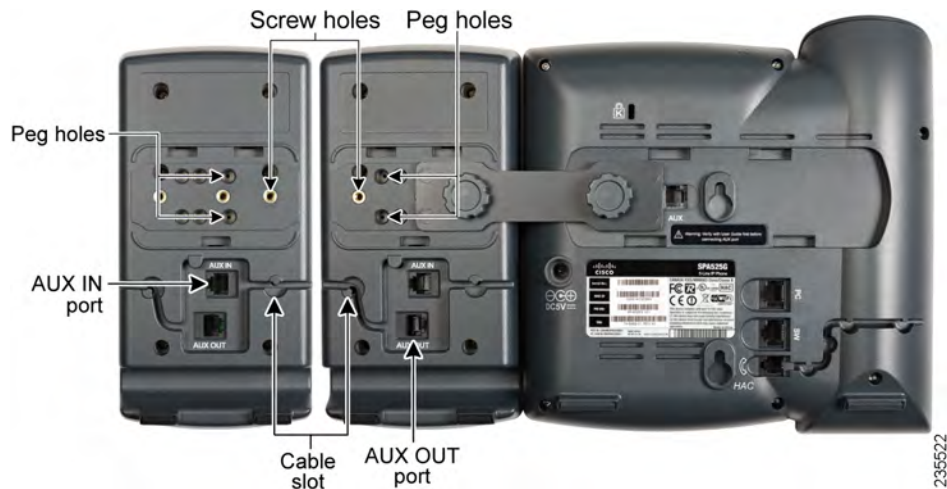

- STEP 10** Attach the appropriate desktop stands to each unit.

Configuring the Cisco SPA 500S

The Cisco SPA 500S can be configured to easily access other phone lines in the system. For example, buttons on the Cisco SPA 500S can be configured to monitor another extension, speed dial a number, transfer calls to another extension, and more.

**NOTE**

The options available on the Cisco SPA 500S depend on the phone system configuration. Your phone system might not provide all of the features mentioned in this document.

Configuration of the Cisco SPA 500S and assignment of the line buttons is performed by the system administrator and is not described in this document. To configure the Cisco SPA 500S:

- If the Cisco SPA 500S and attached IP phone are part of a Cisco SPA 9000 Voice System, we recommend that you use the Cisco SPA 9000 Setup Wizard. For instructions on using the Setup Wizard, see the *System Configuration Using the SPA 9000 Setup Wizard* document on Cisco.com. See [Appendix B, “Where to Go From Here”](#) for the link to this document.
- If you want to manually configure the Cisco SPA 500S using the web user interface for the IP phone to which the Cisco SPA 500S is attached, see the *Cisco SPA 500 Series and Wireless IP Phone Administration Guide* on Cisco.com. See [Appendix B, “Where to Go From Here”](#) for the link to this document.
- If the Cisco SPA 500S and attached IP phone are used with a Broadsoft or Asterisk server, see the *Cisco SPA 500 Series and Wireless IP Phone Administration Guide* on Cisco.com. See [Appendix B, “Where to Go From Here”](#) for the link to this document.

Using the Cisco SPA 500S

The functions of Cisco SPA 500S buttons may differ depending on configuration. However, in general, you can:

- Monitor an extension by viewing its color. The LED color of a line button gives you information about the line being monitored:
 - Green: The line is idle.
 - Red (steady): The line is in use.
 - Red (blinking): The line is ringing.
 - Orange (steady): The line is not registered; there is a problem with phone connectivity.
 - Orange (blinking): The line is not configured properly.
 - Off: The line is not configured.
- Transfer an active call by pressing the line button on the Cisco SPA 500S. (This requires that the line button is configured as a speed dial for the number to which you are transferring).
- Dial a configured extension by pressing the green line button on the Cisco SPA 500S.
- Pick up a call ringing at the extension by pressing the flashing red line button.

Monitoring the Cisco SPA 500S

To view the status of the Cisco SPA 500S:

-
- STEP 1** Log in to the web interface.
 - STEP 2** Click the **Att Console Status** tab.
-

Where to Go From Here

Cisco provides a wide range of resources to help you obtain the full benefits of the Cisco Small Business IP phone.

Product Resources

Support	
Cisco Small Business Support Community	www.cisco.com/go/smallbizsupport
Online Technical Support and Documentation (Login Required)	www.cisco.com/support
Phone Support Contacts	www.cisco.com/en/US/support/tsd_cisco_small_business_support_center_contacts.html
Software Downloads (Login Required)	Go to tools.cisco.com/support/downloads , and enter the model number in the Software Search box.
Product Documentation	
IP Phone	www.cisco.com/en/US/products/ps10499/tsd_products_support_series_home.html
Accessories	http://cisco.com/en/US/products/ps10042/tsd_products_support_series_home.html
Cisco SPA 9000 Voice System	www.cisco.com/en/US/products/ps10030/tsd_products_support_series_home.html

Cisco Unified Communications 500 Series for Small Business	www.cisco.com/en/US/products/ps7293/tsd_products_support_series_home.html
Cisco Small Business	
Cisco Partner Central for Small Business (Partner Login Required)	www.cisco.com/web/partners/sell/smb
Cisco Small Business Home	www.cisco.com/smb
Marketplace	www.cisco.com/go/marketplace

List of Documents

See the following documents (available at the URLs listed above) for more information about your product.

- *Cisco Small Business Pro IP Phone Model 50X Quick Start Guide*—Installation and initial configuration of your Cisco IP phone.
- *Cisco WBP54G Wireless-G Bridge for Phone Adapters User Guide*—Installation and use of the WBP54G wireless bridge with your Cisco IP phone.
- *Cisco Small Business Pro SPA 500 Series and WIP310 IP Phone Administration Guide*—Administration and advanced configuration of your Cisco IP Phone.
- *Cisco SPA 9000 Voice System Administration Guide*—Administration and configuration of the Cisco SPA 9000 Voice System.
- *Cisco SPA 9000 Voice System Using Setup Wizard Installation and Configuration Guide*—Installing the Cisco SPA 9000 Voice System using the setup wizard.
- *Cisco SPA 9000 Voice System Web-UI Based Product Installation and Configuration Guide*—Installing the Cisco SPA 9000 Voice System using the web user interface.